

C5221

Satin Chrome
 Washing Machine Valves
 1/2" Nom. Compression

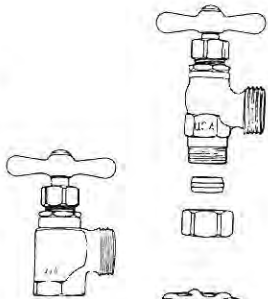

C5209

Satin Chrome
 Washing Machine Valves
 1/2" IPS



C5210 - 1/2" Satin

C5216 - 3/4" Satin

Female Sillcock IPS

C5212 - 1/2" Non-Removable

C5213 - 1/2" Self Draining

Female Sillcock with Vacuum Breaker

C5552 - 1/2"

C5553 - 3/4"

Male No-Kink Hose Bibb

C5554 - 1/2"

C5555 - 3/4"

Female No-Kink Hose Bibb

C5214 - 1/2"

C5215 - 3/4"

Male Hose Bibb IPS

C5217 - 1/2"

C5219 - 3/4"

C5220 - 1"

Garden Valve IPS

C5211 - 1/2"

Loose-Key Lockshield Female Sillcock

C5548

Washing Machine Valve By-Pass
 Satin Chrome

C6337

Fiberglass Shower Stall
 Elbow

C5549 - 1/2" Straight

C5550 - 1/2" Angle

Gas Log Lighter Valves

C5551 - Log Lighter Bar 10" C.I. (NOT SHOWN)



C5222 - 4"

C5223 - 6"

C5224 - 8"

C5225 - 10"

C5226 - 12"

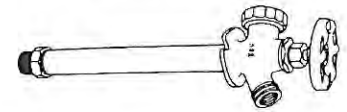

Frost Free Hose Bibbs
 425 Series with Vacuum Breaker
 Order by wall thickness size

C5218 - (No Vacuum Breaker)

Also available in 8" for Loose Key applications

MISC. VALVES

C253 - 1/2" FIP

C254 - 3/4" FIP

Lever Handle Gas Ball Valves
 Female x Female

- Forged brass body
- 3/4" Chrome plated brass ball
- Temperatures up to 175°F
- Threaded ends comply with ANSI B2.1



C198 - Vacuum Breaker

Hose Bib Vacuum Breaker

- 3/4" hose thread
- Brass
- Vandal-proof breakoff screw



C6993 - Size 3/4", NPSM 1",
 Length 2-1/2", NPT 3/4"

C6994 - Size 1", NPSM 1-1/4",
 Length 2-5/8", NPT 1"

Water Meter Coupling Complete

- Heavy cast brass
- Complete with gasket

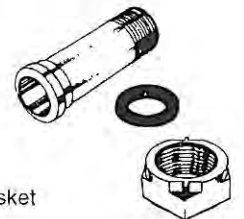

C2757 - 1/2"

C2758 - 3/4"

C2759 - 1"

PVC Ball Valves

- One piece body construction
- EPDM seats and O-Rings
- Working pressure 150psi at 73°F
- Quarter turn operation
- Large flow opening
- Ideal for swimming pools, irrigation and water supply uses
- For cold water lines
- Not for compressed air

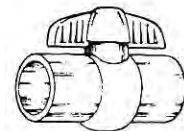

C2760 - 1/2"

C2761 - 3/4"

C2762 - 1"

Threaded Ends - (Not Shown)

GATE VALVES

200# WOG to 200°F

Size	IPS	SWT
1/2"	C1475	C1468
3/4"	C1476	C1469
1"	C1477	C1470
1-1/4"	C1478	C1471
1-1/2"	C1479	C1472
2"	C1480	C1473

BALL VALVES WITH DRAIN

(Not Shown)

Size	IPS
1/2"	C1464
3/4"	C1465
1"	C1467

GATE & WASTE VALVES

(Not Shown)

Size	IPS	SWT
1/2"	—	C1483
3/4"	C1487	C1484
1"	C1488	C1485

CHECK VALVES

200# WOG to 200°F

Size	IPS	SWT
1/2"	C1489	C1497
3/4"	C1490	C1498
1"	C1491	C1499
1-1/4"	C1493	—
1-1/2"	C1494	—
2"	C1495	—

BALL VALVES

600 PSI WOG 150 PSI SWP

- Feature (585): • Two-Piece body • Chrome Plated Ball
- Blowout-Proof Stem • Reinforced TFE Seats
- Full Port 1/4" through 1"
- Conventional Port 1-1/4" through 2"

Size	IPS	SWT
1/2"	C1456	C1450
3/4"	C1457	C1451
1"	C1458	C1452
1-1/4"	C1459	C1453
1-1/2"	C1460	C1454
2"	C1461	C1455



Ti-8
THREADED
Gate Valve



Si-8
GATE VALVE
Copper to Copper



Ti-3
CHECK VALVE
Threaded



Si-3
CHECK VALVE
Copper to Copper



T 585-70
Threaded



S-585-70
Copper x Copper

COMPRESSION STOPS

Size	IPS	SWT
1/2"	C1440	C1446
3/4"	C1441	C1447
With Drain (Shown)		
1/2"	C1442	C1448
3/4"	C1443	C1449



BOILER DRAINS

Size	MALE	FEMALE
1/2"	C1438	C1436
3/4"	C1439	C1437



SILLCOCKS

FEM • IPS

Size	CAT. NO.
1/2"	C1434
3/4"	C1435



PVC SLIP-FIX COUPLING

Size	CAT NO.	Size	CAT NO.
1/2"	C1500	1-1/4"	C1503
3/4"	C1501	1-1/2"	C1504
1"	C1502	2"	C1505

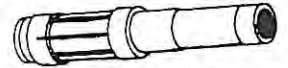

32



RED-WHITE VALVE CORP.

BALL VALVES

150# WSP 600# WOG

• AGA Rated • Full Port

Size	IPS (5044)	SWT (5049)
1/4"	C3381	-
3/8"	C3382	-
1/2"	C3383	C3389
3/4"	C3384	C3390
1"	C3385	C3391
1-1/4"	C3386	C3392
1-1/2"	C3387	C3393
2"	C3388	C3394

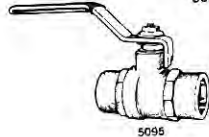
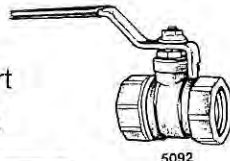
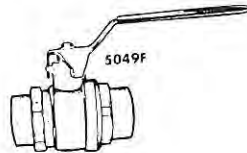
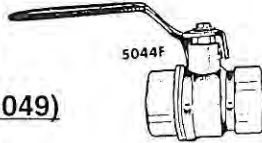

BALL VALVES

125# WSP 400# WOG Standard Port

Size	IPS (5092)	SWT (5095)
1/2"	C3401	C3406
3/4"	C3402	C3407
1"	C3403	C3408
1-1/2"	C3404	-
2"	C3405	-

BALL & WASTE - (NOT SHOWN)

150# WSP 600# WOG

Size	IPS	SWT
1/2"	C3395	C3398
3/4"	C3396	C3399
1"	C3397	C3400

CHECK VALVES

Size	Horizontal	Size	Vertical
3/8"	C3358	3/8"	C3361
1/2"	C3359	1/2"	C3362
3/4"	C3360	3/4"	C3363 (Spring Loaded)

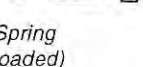
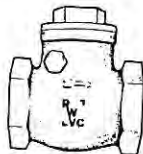

GATE VALVES

200# WOG

Size	IPS (267)	SWT (268)
1/2"	C3366	C3372
3/4"	C3367	C3373
1"	C3368	C3374
1-1/4"	C3369	-
1-1/2"	C3370	-
2"	C3371	-

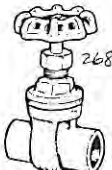
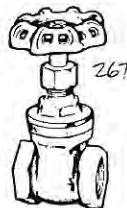

GATE VALVES

125# WSP 200# WOG

Size	IPS (206)	SWT (207)
1/2"	C3346	C3352
3/4"	C3347	C3353
1"	C3348	C3354
1-1/4"	C3349	C3355
1-1/2"	C3350	C3356
2"	C3351	C3357



GATE WITH DRAIN VALVES

Size	IPS (200)	SWT (201)
3/4"	C3340	C3342
1"	C3341	C3343



COMPRESSION STOPS

#RW 193

Compression Stop IPS

C3333 - 1/2"

C3334 - 3/4"



#RW 203

Stop with Drain IPS

C3344 - 1/2"

C3345 - 3/4"



#RW 502

Boiler Drain, Male thread (with CxC) x Hose

C3377 - 1/2"

C3378 - 3/4"



#RW 503

Boiler Drain IPS x Hose

C3379 - 1/2"

C3380 - 3/4"



#RW 301

Hose Bibb Male thread (with CxC) x Hose

C3375 - 1/2"

C3376 - 3/4"



#RW 252

Sillcock IPS x Hose

C3364 - 1/2"

C3365 - 3/4"



HYDRANT PARTS

JOHNSON

C3328
 KIT No. 8
 HYDRASAN I & II NON-FREEZE

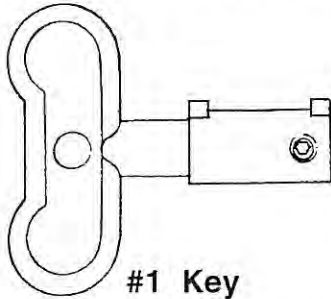

#1 Key

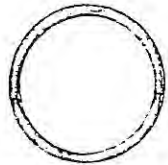

#6 O-Ring

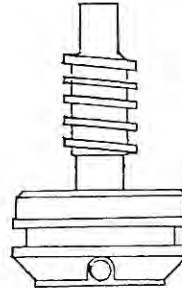

Actuator

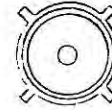

#4 Shuttle

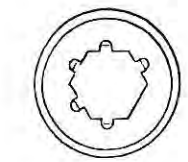
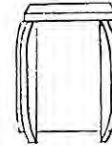

Hex Key



#5/15 Seal/Seat

JOHNSON

C3326
 KIT No. 21
 1410N OLD STYLE

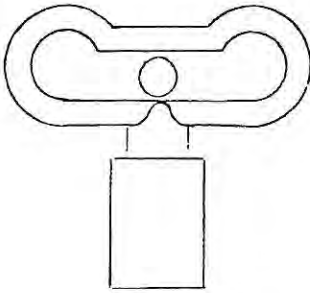

#1 Key

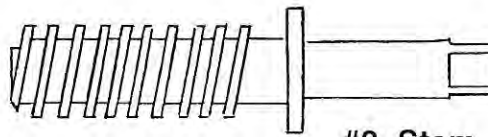

#2 Stem

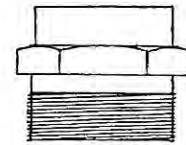

#4 Packing Nut

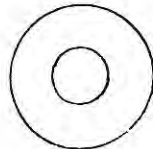

#3 Washer

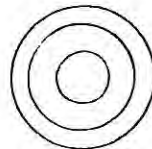

#5 Packing

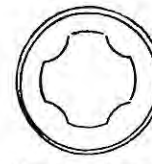

#12 Seat

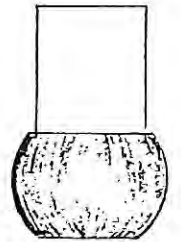

#15 Plunger

JOHNSON

C3327
 KIT No. 22
 71500-71550 NEW STYLE

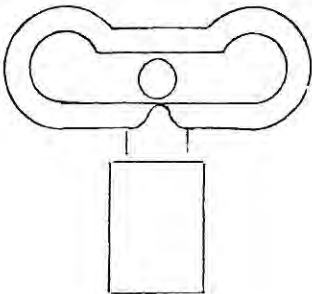

#1 Key

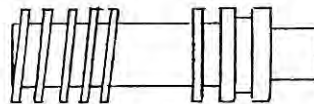

#2 Stem



#38 Stem Seal

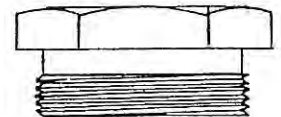

#6 Stem Nut

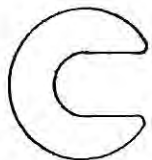

#3 Washer

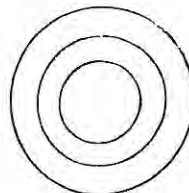

#37 Nylon Seal

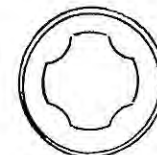

#12 Seat

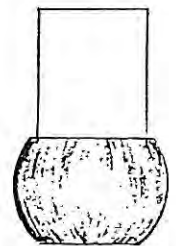

#15 Plunger



HYDRANT PARTS

*KIT - New Style C123
*KIT - Old Style C124

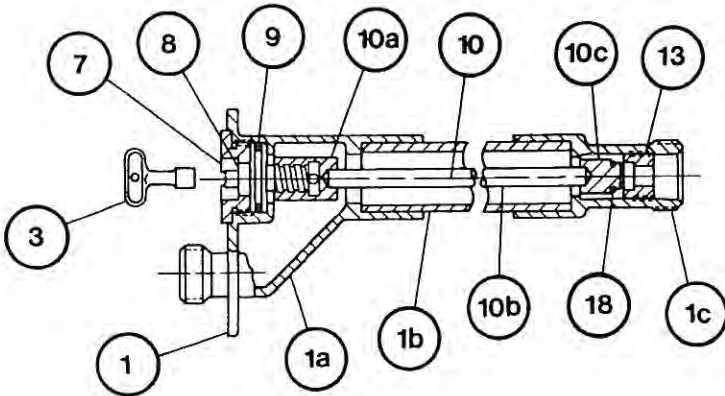

REPLACEMENT PARTS LIST - SPECIFY FIGURE NO. WHEN ORDERING				
No.	DESCRIPTION	No.	DESCRIPTION	
1	Head/Casing Assembly	9	Operating Screw "O" Ring C125 *	
1a	Head	10	Operating Rod Assembly	
1b	Casing	10a	Coupling	
1c	Valve Housing	10b	Rod	
3	Key	10c	Plunger	
7	Face Nut	C121	13	Removable Seat C120 *
8	Operating Screw NS	C122	18	Plunger "O" Ring
*8	Operating Screens OS	C123		
		C124		

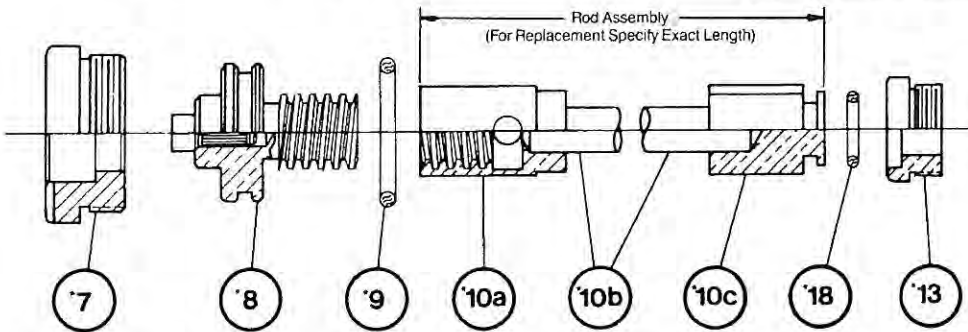

MAINTENANCE INSTRUCTIONS

1. Shut off water supply.
2. Remove face nut.
3. Pull stem out for complete access to all working parts.
4. Check all working parts for replacement.
5. Replace complete stem assembly and face nut.

* These parts are accessible from face of hydrant by removing face nut.

FREEZELESS WALL FAUCET MODEL 14 SERIES

SPECIFICATIONS:

- Nozzle** - 3/4" Male hose thread
- Packing Nut** - Adjustable with teflon impregnated packing
- Valve Operating Threads** - Full circle threads on valve body and retainer
- No Lead Solder** - All solder joints
- Seat Washer** - Standard "O" size
- Flange and Handle** - Polycarbonate

Model 14 wall faucets are used for homes, service stations, churches, motels, drive-in restaurants - outside water service regardless of temperature.

- Permanent Stainless Steel Seat** - will not wire draw
- Adjustable Flange** - Pivots to fit flush with any wall
- Adjustable Packing Nut** - With teflon impregnated packing
- Modern Handle Design** - Handle fits with precision spline - can be used as loose key

COMPLETE FAUCETS			
CAT. NO.	SIZE	CAT. NO.	SIZE
C3451	6"	C3449	10"
C3452	8"	C3450	12"

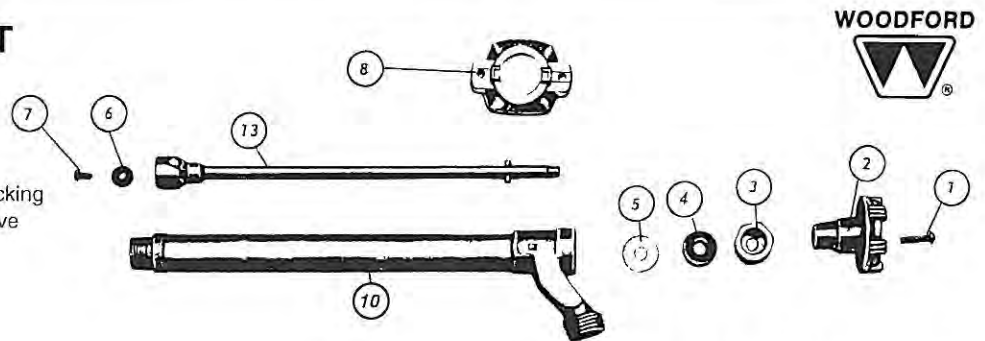

PART NUMBER 3500X Valve Stem Assembly
(As illustrated below with rubber and screw)

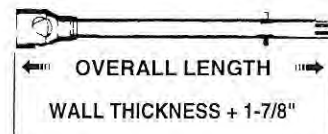

NOTE: To obtain the correct part please send both the model number and wall thickness. If this is not possible then either the overall dimension as shown above or the sample part must be furnished.

CAT. NO.	ITEM	PART NO.	DESCRIPTION
C3461	1	30002	Handle Screw
C3465	2	30099	Wheel Handle
	3	30059	Packing Nut
C3462	4	30005	Packing
	5	30006	Packing
			Support Washer
C3463	6	30008	Valve Seat Rubber
C3464	7	30009	Retainer Screw for Rubber
	8	30098	Adjustable Flange
	10	3503X	"P" Inlet Casing Assembly (specify length)
	13	3500X	Valve Stem Assembly (specify length, see chart)

35

934 S.E. Sixth Avenue • Portland, Oregon 97214 • (503) 235-2167 • (800) 929-5039 • Fax (503) 239-3774

WOODFORD



MODEL 17 PARTS LIST

CAT. NO.	ITEM	PART NO.	DESCRIPTION
C3461	1	30002	Handle Screw
C3465	2	30099	Wheel Handle
	3	30059	Packing Nut
C3462	4	30005	Packing
	5	30006	Packing
			Support Washer
C3463	6	30008	Valve Seat
			Rubber
C3464	7	30009	Retainer Screw for Rubber
	8	30098	Adjustable Flange
	9	30415	Vacuum Breaker Cap
	10	30414	Vacuum Breaker Body
	11	36049	Vacuum Breaker Float Assembly
	13	3562X	"P" Inlet Casing Assembly (specify length)
	16	3500X	Valve Stem Assembly (see chart)
	17	30418	Check Valve

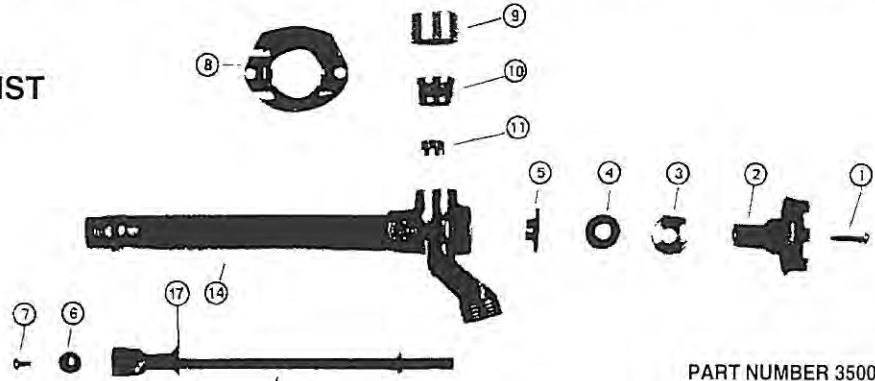

PART NUMBER 3500X
Valve Stem Assembly
(As illustrated below with rubber and screw)

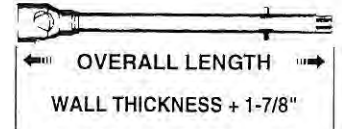

COMPLETE FAUCETS			
CAT. NO.	SIZE	CAT. NO.	SIZE
C3455	6"	C3453	10"
C3456	8"	C3454	12"

4" WALL	= 5 7/8"	*
6" WALL	= 7 7/8"	C3468
8" WALL	= 9 7/8"	C3469
10" WALL	= 11 7/8"	C3470
12" WALL	= 13 7/8"	*
14" WALL	= 15 7/8"	*
18" WALL	= 19 7/8"	*
24" WALL	= 25 7/8"	*

WOODFORD



MODEL 25 PARTS LIST

CAT. NO.	ITEM	PART NO.	DESCRIPTION
	1	30234	Handle Screw
C3467	2	30233	Wheel Handle-metal
	3	30236	Drain Guard
	4	30241	Head Nut - brass
	5	30238	Stem Screw
	6	35280	Drain Valve Assembly
	1, 2, 3, 4, 5, 6		Repair Kit (see above note)
	7	303XX	Operating Rod
C3466	8	30230	Plunger Assembly
	9	55057	Vacuum Breaker-brass
	11	3545X	"P" Inlet Casing Assembly (specify length)

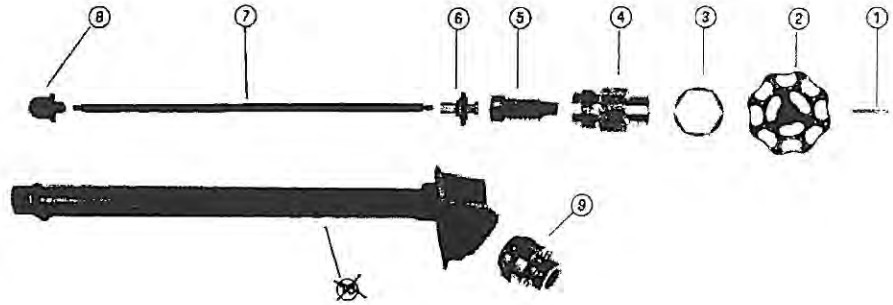

OPERATING ROD
(As illustrated below)

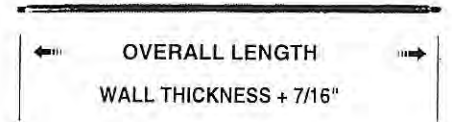

COMPLETE FAUCETS			
CAT. NO.	SIZE	CAT. NO.	SIZE
C3457	10"	C3459	6"
C3458	12"	C3460	8"

NOTE: REPAIR KIT C3471 (35300)

Consists of items 1 through 6 & 8.

If replacement of items 4, 5 or 6 is necessary on a faucet with a plastic head nut, then all should be replaced. This insures proper function of faucet. Order the kit above to accomplish this. If you have a brass head nut you may order individual parts.



4" WALL	= 4 7/16"	*
6" WALL	= 6 7/16"	*
8" WALL	= 8 7/16"	*
10" WALL	= 10 7/16"	*
12" WALL	= 12 7/16"	*
14" WALL	= 14 7/16"	*
18" WALL	= 18 7/16"	*
24" WALL	= 24 7/16"	*

WOODFORD



**Sanitary
Automatic Draining
Freezeless Wall Hydrants**

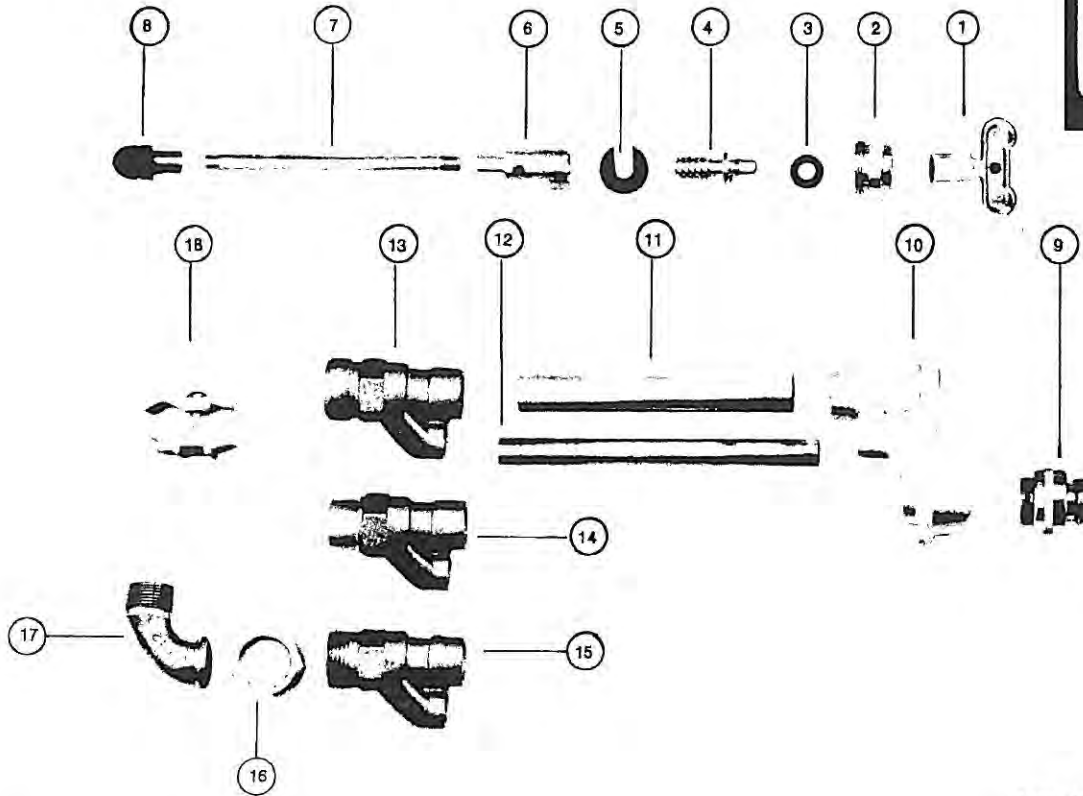
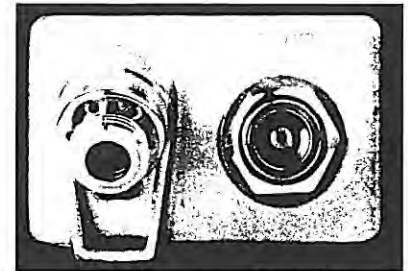

CAT. NO.	ITEM	PART NO.	DESCRIPTION
C3472	1	50009	Tee key
C3479	2	50253	Head nut - chrome
C3478	3	50252	Stem washer
C3483	4	55062	Stem screw
C3477	5	50251	"C" Washer
C3481	6	51014	Yoke nut
	7	504XX	Operating rod (see note for dimension "A")
		554XX	Operating rod assembly (includes 51014, 504XX and 50250, see note for dimension "B")
C3476	8	50250	Plunger
	9	55060	Vacuum breaker - chrome
	10	50194	Head - chrome
	11	5033X	3/4" Tube (specify length)
	12	5036X	1/2" Tube (specify length)
	13	50287	Valve body - 3/4" female pipe
	14	50288	Valve body - 3/4" copper
	15	50289	Valve body - union connector / 1" male pipe thread
	16	50049	Union nut
	17	50045	Elbow - union connector - 3/4" male pipe
	18	55063	Wall Clamp Assembly

**PART NO. 504XX—
Operating Rod**

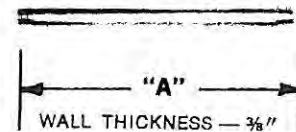

**PART NO. 554XX—
Operating Rod Assembly**

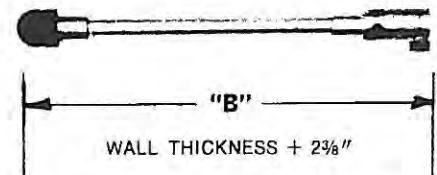

NOTE: To order, specify Model and wall thickness or send in wanted part. If not feasible send the dimension for "A" or "B" as shown above.

934 S.E. Sixth Avenue • Portland, Oregon 97214 • (503) 235-2167 • (800) 929-5039 • Fax (503) 239-3774

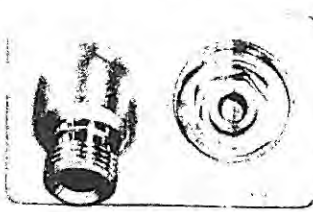

Woodford Freeless Model 80



Woodford Freeless Anti-Contamination Model 85

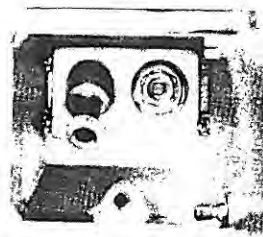

Woodford Freeless Model 90

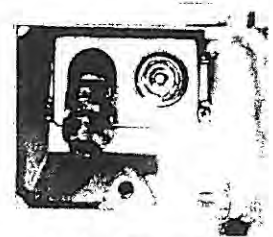

Woodford Freeless Anti-Contamination Model 95

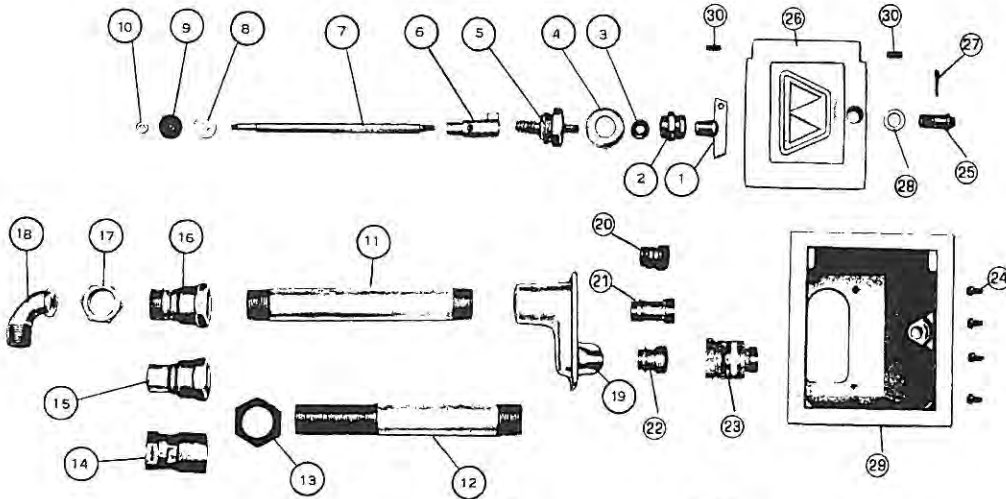

Freeless Wall Hydrants
Model Numbers
80, 85, 90, 95

PART NUMBER 533XX – Operating Rod

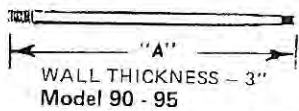

WALL THICKNESS IS ROD LENGTH
Model 80 - 85

NOTE: To obtain the correct part please send both the model number and wall thickness. If this is not possible then either dimension "A" (as shown above) or the sample part must be furnished.

PART NUMBER 553XX – Operating Rod Assembly

(Includes parts 51014, 533XX, 50027, 51013, & 50028).

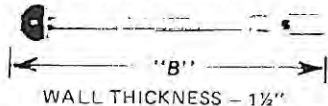

WALL THICKNESS - 1 1/2"
Model 90 - 95

WALL THICKNESS + 1 1/2"
Model 80 - 85

NOTE: To obtain the correct assembly send both the model number and wall thickness. If this is not possible then either dimension "B" (as shown above) or the sample part must be furnished.

CAT. NO.	ITEM	PART NO.	DESCRIPTION	WHERE USED
C3472	1	50009	Tee key	80, 85, 90, 95
C3485	2	55111	Packing nut assembly	80, 85, 90, 95
C3473	3	50024	Packing	80, 85, 90, 95
C3482	4	51030	Head nut cover	80, 85, 90, 95
C3484	5	55110	Head nut assembly	80, 85, 90, 95
C3481	6	51014	Yoke nut	80, 85, 90, 95
	7	533XX	Operating rod (see note for dimension "A")	80, 85, 90, 95
		553XX	Operating rod assembly (see note for dimension "B")	80, 85, 90, 95
C3475	8	50027	Plain support washer	80, 85, 90, 95
C3480	9	51013	Ball valve rubber	80, 85, 90, 95
C3474	10	50028	Round brass nut	80, 85, 90, 95
	11	501XX	Pipe casing (specify length)	80, 85, 90, 95
	12	50XXX	Pipe casing - extended thread (specify length)	80, 85, 90, 95
	13	50025	Pipe lock nut	80, 85, 90, 95
	14	51056	Valve seat body - 3/4" female pipe thread inlet	80, 85, 90, 95
	15	50052	Valve seat body - 3/4" copper tube inlet	80, 85, 90, 95
	16	50050	Valve seat body - Union connector	80, 85, 90, 95
	17	50049	Union nut	80, 85, 90, 95
	18	50045	Elbow union connector - 3/4" male pipe thread inlet	80, 85, 90, 95
	19	51007	Head casting - chrome	80, 85, 90, 95
	20	50004	Hose nozzle	80
	21	51016	Nozzle	90
	22	51051	Nozzle	85 95
C3486	23	75101	Vacuum breaker - chrome (34HW)	85 95
	24	51049	Screw - 4 required	90, 95
	25	51042	Door lock screw	90, 95
	26	51035	Hydrant box door - chrome	90, 95
	27	50042	Cotter pin	90, 95
	28	51043	Door lock screw washer	90, 95
	29	50185	Hydrant box - chrome	90, 95
	30	50040	Hinge pin (2 required)	90, 95

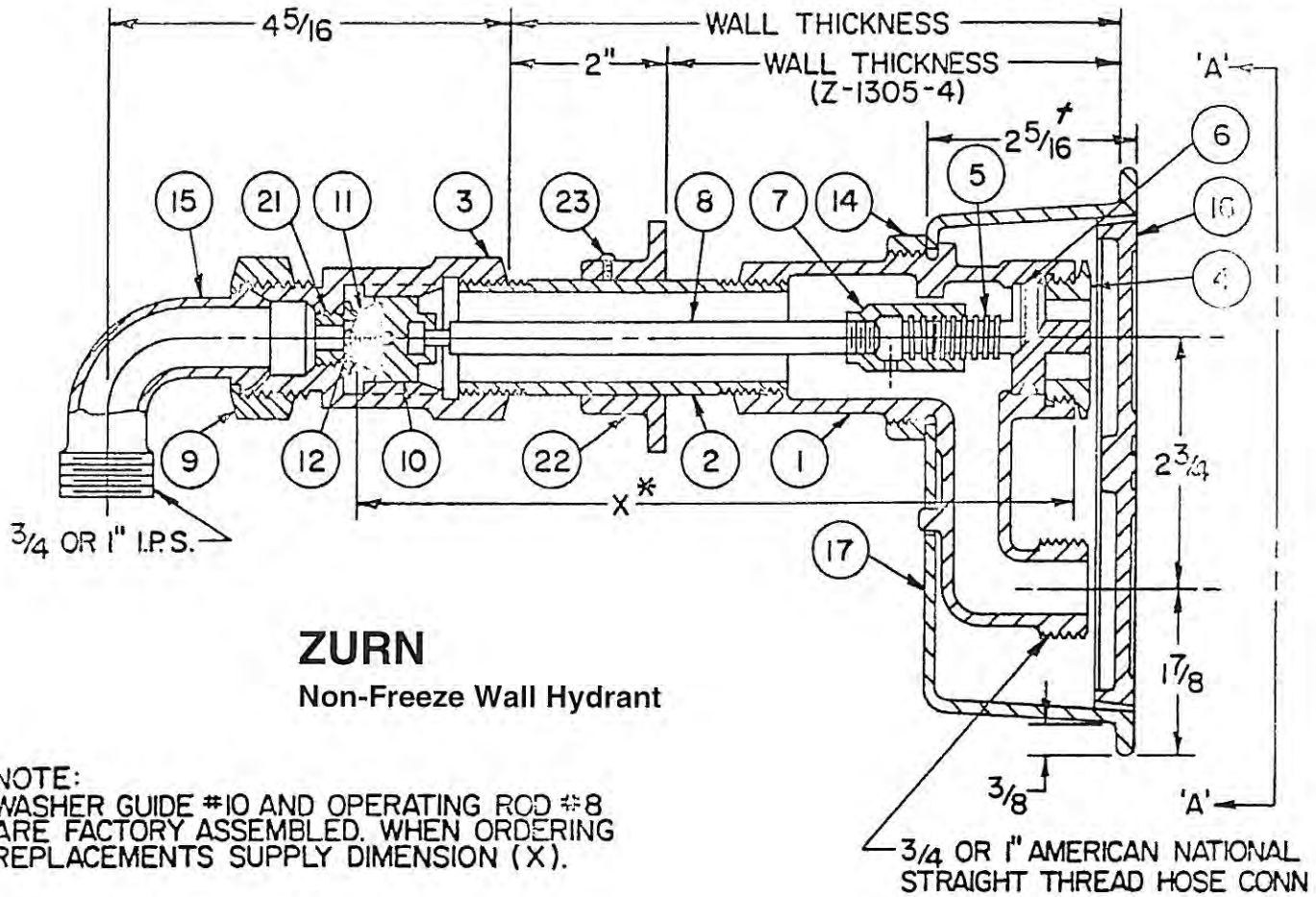

ZURN
Non-Freeze Wall Hydrant

NOTE:
* WASHER GUIDE #10 AND OPERATING ROD #8 ARE FACTORY ASSEMBLED. WHEN ORDERING REPLACEMENTS SUPPLY DIMENSION (X).

ITEM	NAME
1	HEAD
2	CASING
3	VALVE HOUSING
4	FACE NUT
5	OPERATING SCREW
6	"O" RING
7	OPERATING COUPLING
8	OPERATING ROD
9	UNION NUT
10	WASHER GUIDE
11	WASHER (NEOPRENE)
12	SCREW 3/16-24 N.C.

C7030

C7031

C7032

C7033

C7027

C7028

C7029

ITEM	NAME
13	KEY (NOT SHOWN)
14	LOCKNUT
15	UNION ELL
16	COVER
17	BODY
18	LOCK PIN MOUNTING
19	LOCK PIN
20	HINGE PIN
21	REMOVABLE SEAT
22	WALL LOCKNUT
23	LOCKNUT SCREW