

**100% STAINLESS STEEL  
5/16" Hex Head Screw**

For use in outdoor, fresh water, and mildly corrosive applications. Stainless steel band and housing, with 410 stainless steel, slotted hex head screw. 64000 Series

NO.	FITS	SIZE	NO.	FITS	SIZE
C3216	3/8" ID.	#8	C3211	1-1/2" ID.	#24
C3207	5/8" ID.	#10	C3212	2" ID.	#32
C3208	3/4" ID.	#12	C3213	2-1/2" ID.	#40
C3209	1" ID.	#16	C3214	4" ID.	#64
C3210	1-1/4" ID.	#20			

**MINIATURE HOSE CLAMPS**

NO.	FITS	SIZE
C3217	5/16" ID.	#2
C3219	1/2" ID.	#10



**STOVE BOLTS**

- Round head • With hex nuts
  - Plated • Packed 100 bolts & nuts per box
- C4604** 1/4" X 1"



**FLAT HEAD WOOD SCREWS**

- Packed 100 per box • Brass
- C4601** 1 1/2" Size #12  
**C4602** 2" Size #12



**DRIVE SCREWS**

- Packed 100 per box
- C4603** 2" X #16



**SELF-DRILLING SCREWS**

- Packed 100 per box • 1/4" hex head
  - Self-drilling point
- C4611** 1/2" x #8



**PASCO GAUGES**

- Steel case • 1/4" MPT brass connection
- Plastic face • Durable, patented movement

- C4606** 30# P.S.I. Rating  
**C4607** 60# P.S.I. Rating  
**C4608** 100# P.S.I. Rating  
**C4609** 200# P.S.I. Rating

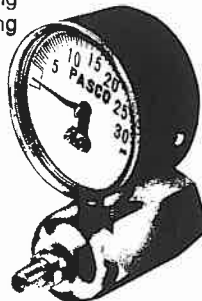
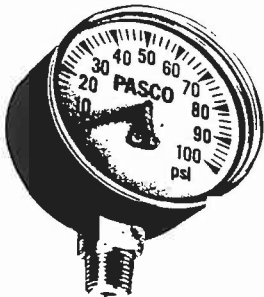

**GAS TEST GAUGE ASSEMBLY**

- Unbreakable plastic face
- Steel case
- All parts precision made and assembled
- Adapts to 3/4" MPT

**C6800** 100# Gauge

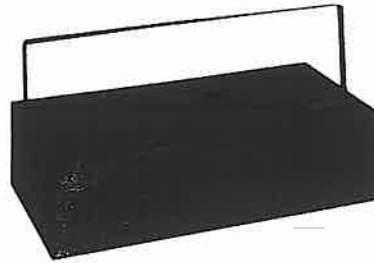

**FITTING TOTE TRAY  
C4621**

- Enamel Finish Steel  
Excellent for Copper Fittings
- 8 Compartments
  - 18 Gauge
  - 20" x 10" x 5"

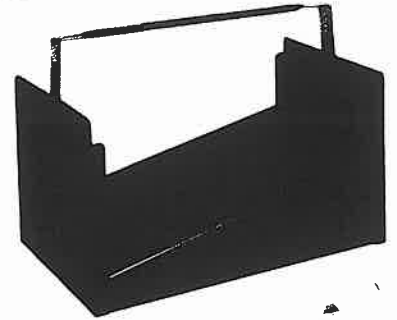

**NIPPLE BOXES**

NO.	SIZE	HOLDS
C4618	1/2"	77
C4619	3/4"	66
C4620	1"	50

Enameled Steel

**HOT WATER THERMOMETERS**

Spirit Column Type  
Dual Scale  
40 - 260° Fahrenheit  
0° - 120° Centigrade  
5° Increments

- C4599** Steel Angle  
**C4600** Steel Straight

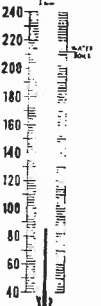
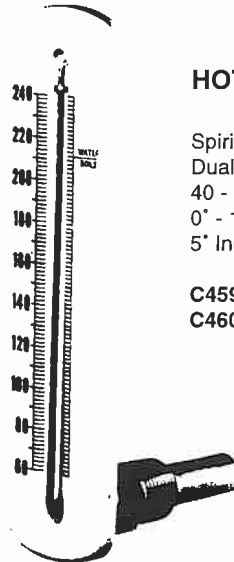

**ECONO TEST PLUG**

Designed with a rubber flange that grips the end of the pipe preventing slippage while tightening. For plastic, cast iron and copper pipe. 3" and 4" test plugs supplied with superflu wingnut to prevent breaking of nuts when you tighten with pliers.

- C4633** 1 1/2" | **C4634** 2"  
**C4635** 3" | **C4636** 4"



**VALVE WRENCHES**

For Tub and Shower

- Used to remove the bonnet nuts of built-in valves
- Socket is long enough to penetrate the wall thickness to reach the nut

- C4671** 1 set of 5 sockets, bar and wire holder  
**C4666** 21/32 x 27/32 Socket Wrench  
**C4667** 29/32 x 31/32 Socket Wrench  
**C4668** 1-1/32 x 1-3/32 Socket Wrench  
**C4669** 1-5/32 x 1-9/32 Socket Wrench  
**C4670** 1-11/32 x 1-7/16 Socket Wrench

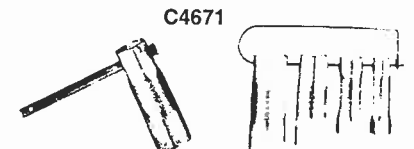

**WRENCH EACH OF:**

- 21/32 x 27/32, 29/32 x 31/32,  
1-1/32 x 1-3/32, 1-5/32 x 1-9/32,  
1-11/32 x 1-7/16,  
Plus 6" Bar and Wire Holder

934 S.E. Sixth Avenue • Portland, Oregon 97214 • (503) 235-2167 • (800) 929-5039 • Fax (503) 239-3774

- C6830 Basin Wrench, 11" Heavy Duty Handle.
- C4313 Basin Wrench to 1-1/8" Capacity
- C4314 Basin Wrench to 2" Capacity
- C4659 3-In-1 Combination Wrench, Malleable Iron; for Spuds, Strainers and Slip Joint Nuts
- C4660 Strap Wrench, 7" Handle, 2" I.P.S. Capacity,
- C4664 **P.O. Plug Wrench**, Holds Pop-Up Plugs and Basket Strainers in Position and Keeps Them From Turning During Installation
- C4665 **Spud Wrench**, 1"-4" Capacity; Hardened Steel for Removal or Installation of Closet Spuds, Sink Strainers, P.O. Plugs, Waste and Overflows, 1/Bx.
- C4663 Cleanout Plug Wrench
- C4317 Seat Hinge Nut Wrench For Toilet Seat
- C4320 **Faucet Seat Dresser**, Standard Grade, 3 Cutters: 1/2", 1 1/8", 3/4", Reversible Double Cone Guide, 1/Bx.

**TINY TIM HACKSAW** *The highest quality made.*

- Cuts wood, plaster, steel, brass, etc.
- Vinyl grip handle • 1/4" x 6" 32T Blade

- C4627 Hacksaw with blade
- C4628 Extra blades 10/pkg.

**ADJUSTABLE SPUD WRENCH**

- 10" length • 1" to 3" capacity
- For slip nuts, lock nuts and strainer nuts

**METER KEY SOCKET HEAD**

- Make any length meter key using 1/2" IPS thread pipe and this socket.

**METER KEY**

- C4656 5/8" X 28"
- C4626 3/4" X 28"

(Not Shown)  
C5511 - 30" Sprinkler Key

**TUBING CUTTER**

- 3/16" to 1 1/8" • Grooved roller
- Retractable reamer • Extra wheel in handle
- Chrome Vanadium cutting wheel

**FLARING TOOL**

- For O.D. sizes • Makes smooth flare
- 3/16" - 1/4" - 5/16" • Packed in pouch
- 3/8" - 1/2" - 5/8"

**SWEDGE TOOL**

- Size 3/8" to 3/4" • For copper tubing

**RADIATOR SPUD WRENCH**

**SET**

- Set Includes: • 1-3/8" x 7/16" ratcheting box wrench
- 1-small hex/large hex tapered bibb seat tool
  - 1-small square/large square tapered bibb seat tool
  - 1-small square/large square no taper bibb seat tool

**BIBB SEAT TOOL - BENT**

- Cadmium plated • Heat treated

- C4673 6-step, Fits 80% of all faucets
- C4672 Tapered, Fits all faucets

**"A" Quality COPPER FITTING BRUSH**

- 2 wire model • High carbon crimped steel brushes
- Sizes indicated are nominal copper

- C4337 3/8" C1106 1"
- C1104 1/2" C4335 1 1/4"
- C1105 3/4"

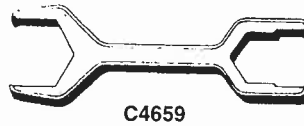

C4659



C6830

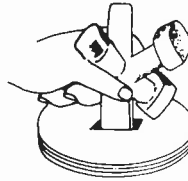

C4663



C4660



C4317

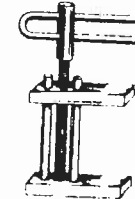

C4665

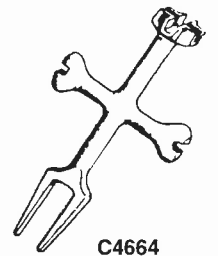

C4664



C4320



C4627

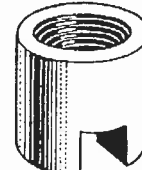

C4625

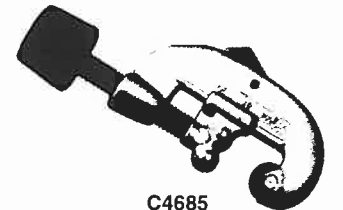

C4685

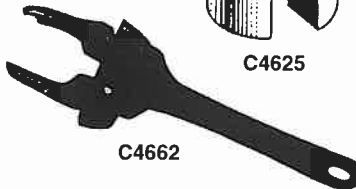

C4662

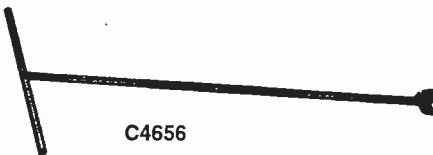

C4656

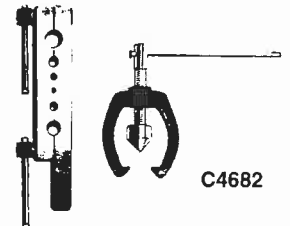

C4682



C4661

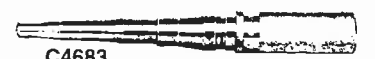

C4683

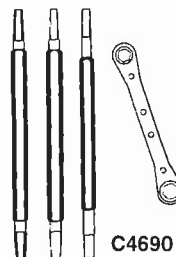

C4690

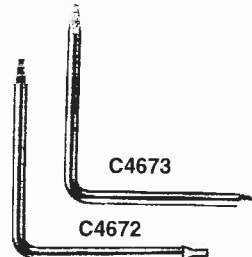

C4673

C4672

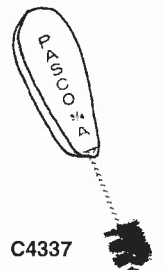

C4337

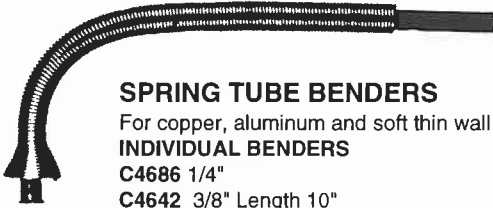

**SPRING TUBE BENDERS**

For copper, aluminum and soft thin wall tubing  
**INDIVIDUAL BENDERS**

- C4686 1/4"
- C4642 3/8" Length 10"
- C4687 1/2"
- C4688 5/8"



**C4629 UTILITY KNIFE**

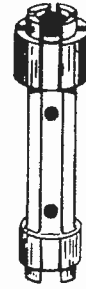

**THE "SMART" DUMBBELL**  
**TUB DRAIN AND SPUD WRENCH**

HEAVY DUTY DIE CAST ALUMINUM  
FITS 95% OF ALL TUB DRAINS  
INSTALLS OR REMOVES DRAINS WITHOUT CROSSBARS  
(KOHLER, AMERICAN STANDARD)  
FITS 1 1/2" AND 2" CLOSET SPUDS

**C4632**

**FOUR WAY KEY**  
PRECISION MACHINED - PLATED STEEL

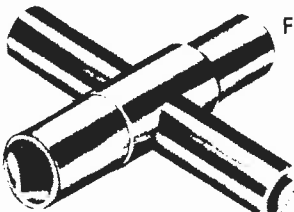

FITS:  
STOPCOCKS, SILLCOCKS  
VALVES  
SIZES:  
1/4" - 9/32"  
5/16" - 11/32"

PART NUMBER	C4605
-------------	-------

**CHROME PLATED SLIP-JOINT PLIERS**



Wide-opening jaws will take slip nut up to 2" O.D  
Chrome-plated, vinyl-covered handles

Part No	Description	Case Cont
C2360	10-Inch Pliers	6



**ACID BRUSHES**  
Natural Bristle

NO.	SIZE	LNGLH	DIA	BRISTLE
C1110	#1 Metal	5 1/4"	1/4"	3/8" 25/32"
C1111	#2 Metal	5 1/2"	5/16"	1/2" 13/16"

**CLASSIC DRAIN WRENCH**  
C4644

Tightens most fiberglass shower stall drain locknuts and die cast basket strainer locknuts.

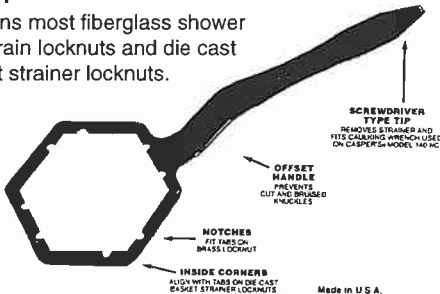

- High impact plastic
- High carbon steel
- Replacement brushes
- 1/2" x 3/4" Copper

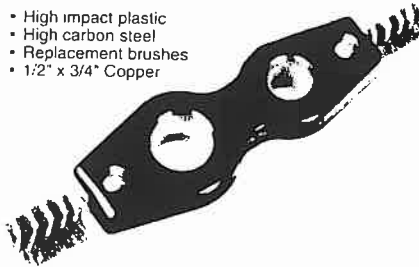

**4-IN-1 FITTING BRUSH**

Tube Cleaning and Fitting Brush

NO.	DESCRIPTION
C1112	4-IN-1 Brush
C1113	Replacement Brush Kit

Includes 2 ID & 2 OD Brushes

- Fits 3 1/2" plastic locknuts
- Fits 3 3/8" die cast basket strainer locknuts
- Fits brass locknut on Casper's® brass shower stall drains
- Stamped steel
- 13" overall length
- Offset handle for close quarter work
- Cushion grip

**C5228 4 in 1 SCREW DRIVER**



**C5229 2 in 1 SCREW DRIVER**

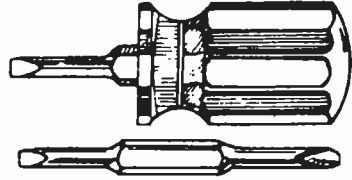

C5233	1 SLOTTED TYPE BIT
C5232	1 PHILLIPS TYPE BIT
C5231	1 COMBO BIT

**INTERNAL PIPE WRENCH**



- C4678 - 3/8"
- C4679 - 1/2"
- C4680 - 3/4"
- C4681 - 1"



**NIPPLE AND SCREW EXTRACTORS**

- Removes nipples, bolts and screws
- Left hand spiral tapered flute removes broken piece without thread damage

C4639	- 1/2"	17/32"	7/8" to 1 1/8"
C4640	- 3/4"	13/16"	1 1/8" to 1 3/8"
C4641	- 1"	1 1/16"	1 3/8" to 2"

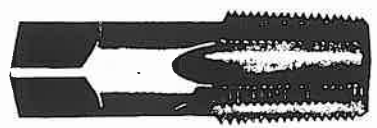

**PIPE TAPS**

- High carbon steel
- Tapered thread taps

C4674	- 1/8"	27	.3924	R
C4675	- 1/4"	18	.5946	7/16
C4637	- 1/2"	14	.7815	45/64
C4638	- 3/4"	14	.7935	59/64
C4676	- 1"	11-1/2	.9845	45/64
C4677	- 1-1/4"	11-1/2	1.0085	1-1/2

PASCO



**RAM BITS**  
C4622 - 1 1/2"  
C4623 - 2" C4624 - 3"

277

934 S.E. Sixth Avenue • Portland, Oregon 97214 • (503) 235-2167 • (800) 929-5039 • Fax (503) 239-3774

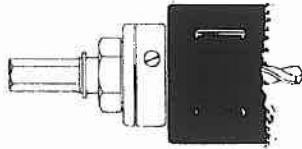
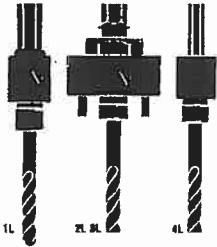

## ARBORS

	Boxed	Fits Hole Saws	Shank Type	Chuck Size	
	Product No.			In.	mm
C2637	30001-1L	9L-19L	Hex	1/2	13
C2638	30002-2L	20L-96L	Hex	1/2	13
C2639	30004-4L	9L-19L	Round	1/4	6

## C2663

## HOLE SAW KITS

PLUMBER NO. 30808-600P

Six sizes most commonly used for pipe tap and entrance. One each hole saws 3/4", 7/8", 1 1/8", 1 1/2", 1 3/4", 2 1/4". One each arbors 2L, 4L. One spare pilot drill. One arbor adapter. Plastic case.

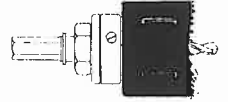

**CALL!**

**HACK SAWS BLADES INSTOCK**

## HOLE SAWS SIZES

	Diameter In.	mm	Boxed Product No.	Use Arbor No.	Pipe Tap In. (mm)	Pipe Entrance In. (mm)
C2640	3/4	19	30012-12L	1L, 4L, 5L	1/2 (13)	3/8 (10)
C2641	7/8	22	30014014L	1L, 4L, 5L	3/4 (19)	1/2 (13)
C2642	1	25	30016-16L	1L, 4L, 5L		
C2643	1 1/8	28	30018-18L	1L, 4L, 5L	1 (25)	3/4 (19)
C2644	1 1/4	32	30020-20L	2L or 6L		
C2645	1 3/8	35	30022-22L	2L or 6L		1 (25)
C2646	1 1/2	38	30024-24L	2L or 6L	1 1/4 (32)	
C2647	1 3/4	44	30028-28L	2L or 6L	1 1/2 (38)	1 1/4 (32)
C2648	2	51	30032-32L	2L or 6L		1 1/2 (38)
C2649	2 1/8	54	30034-34L	2L or 6L		
C2650	2 1/4	57	30036-36L	2L or 6L	2 (51)	
C2651	2 1/2	63	30040-40L	2L or 6L		2 (51)
C2652	2 5/8	67	30042-42L	2L or 6L	2 1/2 (63)	
C2653	2 3/4	70	30044-44L	2L or 6L		2 1/2 (63)
C2654	3	76	30048-48L	2L or 6L		
C2655	3 1/4	83	30052-52L	2L or 6L	3 (76)	
C2656	3 1/2	90	30056-56L	2L or 6L		
C2657	3 5/8	92	30058-58L	2L or 6L		3 (76)
C2658	3 3/4	95	30060-60L	2L or 6L	3 1/2 (90)	
C2659	4	100	30064-64L	2L or 6L		
C2660	4 1/8	105	30066-66L	2L or 6L		3 1/2 (90)
C2661	4 3/4	121	30076-76L	2L or 6L	4 1/2 (115)	4 (100)
C2662	5	127	30080-80L	2L or 6L		

C2630 **Hacksaw** Rugged die-cast aluminum. Designed for hard to get at places. Cuts bolts, wire, tubing and plastic. With bi-metal 10" blade which outlasts up to 10 ordinary blades. Product No. 20975-975



## RECIPROCATING SAW BLADES



CAT NO.	METAL WORK	
C2616	610R	10TPI
C2617	614R	14TPI
C2618	618R	18TPI
	WOOD WORK	
C2620	636R	Rough Cut
C2621	656R	General

Many other sizes available. Call us for information.

## ACCESSORIES

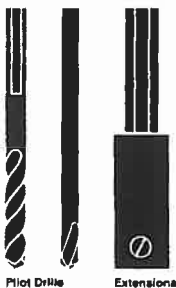

C2666 Pilot Drills 1/4"/6mm dia. No. 4321 fits 1L, 2L, 3L, 4L

C2665 Extensions 30847 12"/300mm; No. 30846



Torque Driving Plates No. 30840-120L fits 48L-66L No. 30841-121L fits 68L-96L

C2667



Arbor Adaptor No. 30857. Adapts 1L, 4L & 5L arbors to saws 1 1/4"/32mm-6"/152mm.

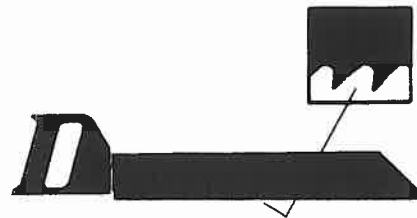

PVC/ABS Plastic Pipe Hand Saw Designed especially to cut PVC and ABS plastic pipe without binding. Can also do other general cutting of plastic and wood. Cuts on both push and pull strokes. Die-cast aluminum handle, replaceable tempered carbon steel 12" or 18" blade.

Product Number	Description
C2631 HSF-180	18"/450mm blade and handle
C2634 HSF-120	12"/300mm blade and handle
C2632 HSB-18	18"/450mm replacement blade
C2633 HSB12	12"/300mm replacement blade

**TAPE**

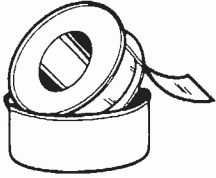

TEFLON TAPE  
C5515 1/2" X 520"  
C5516 3/4" X 520"



C4822  
2" X 60 YARD DUCT TAPE



C6866  
PIPEWRAP TAPE  
UPC® Approved  
2" x 100' x 10ml.



PIPE TOOLS & VISES SINCE 1896

C5238  
MC2 MINI CUTTER

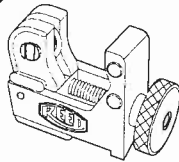

C5236 (TC1Q) 1/8" - 15/16"  
C5237 (TC2Q) 1/4" - 2-5/8"  
TUBE CUTTER

C5243  
RATCHET SHEARS  
For Cutting PVC, CPVC (RS1)

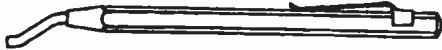
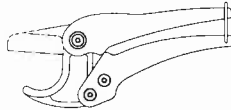

C5246  
DEBURRING TOOL FOR TUBING  
(DEB0)



C4823 - 1 Qt.  
THREAD  
CUTTING OIL

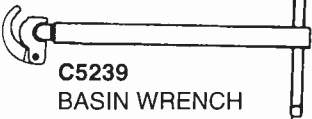

C5239  
BASIN WRENCH

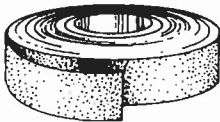

C1108  
WATER RESISTANT SAND CLOTH  
• Made in the U.S.A.  
• Abrasive cloth for cleaning pipe and fittings  
• 120 GRIT - Aluminum Oxide - Water Resistant  
• 1-1/2" x 10 yards

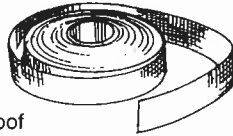

C1107  
OPEN MESH  
• 100% Waterproof  
• Polyester on both sides  
• 1-1/2" x 10 yards  
• Can be exposed to water and solvents indefinitely without breakdown



C1114  
SOLDER  
HEAT SHIELD  
• 9" X 12"

**TurboTorch®**



C5267  
HANDTOURCH  
STK-9 KIT

- Components:
- STK-R Pressure Regulator CGA-600
  - ST-3 Tip
  - Instruction Manual

C5265  
TURBO LITE  
TL-44HS Self-Lighting Torch  
Features:

- Replaces TL-3 and TL-4
  - Replaceable tip-end
  - Heavy-duty piezo ignitor
  - Wide lighting range
  - Heavier case
  - Easy to clean orifice
  - Machined rotor
- USE With: CGA-600, 1 lb. MAPP® or Propane Tanks.  
Tank not included.



C228  
BRIDGIT LEAD-FREE SOLDER  
1 lb. Box

C190  
SILVA BRITE SOLDER  
1 lb. Roll

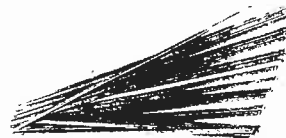

C5266  
BRIDGIT QUICKSILVER SOLDER  
1 lb. Pack - 24 Sticks/Pkg.

C195  
CANFIELD SOLDER  
95/5

C196  
CANFIELD SOLDER  
50/50

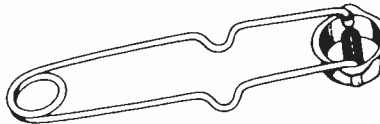

C4630  
SPARK LIGHTER  
C4631  
ADDITIONAL FLINTS  
For Spark Lighter



MAPP AND PROPANE CYLINDERS  
Carton Quantities only (12)

C224 J40-601 14.1 oz. Propane  
C223 J40-600 16 oz. MAPP

934 S.E. Sixth Avenue • Portland, Oregon 97214 • (503) 235-2167 • (800) 929-5039 • Fax (503) 239-3774

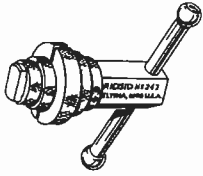

### INTERNAL WRENCH

Mfrs. Code No. 785461

One size for 1" through 2" capacity.

Cat	No.	Model	Size/Capacity
C2867	31405	342	1" thru 2"

Ideal for internal holding on hollow work, holding closet spuds and bath, basin and sink strainers through 2". It can also be used for installing and extracting 1" through 2" nipples and tubing . . . without damaging threads.

Twin multi-size jaws have knurled gripping faces that expand by eccentric action. Jaws are quickly reversed for various sizes. Sliding, reversible handle and its well-balanced, compact size make the RIDGID Internal Wrench ideal especially for work in light quarters.

### ADJUSTABLE WRENCH

Mfrs. Code No. 785461

Cat	No.	Model	Size/Capacity
C2868	31190	706	6" 3/4"
C2869	31195	708	8" 15/16"
C2870	31200	710	10" 1-1/8"
C2873	31205	712	12" 1-5/16"



Designed to speed work in close quarters, these chrome-plated wrenches are made of special alloy, then selective induction hardened for long service life. Design allows fast, easy, one-hand adjustment. When properly tightened, jaw will not slip.

### SPUD WRENCH

Mfrs. Code No. 785461

Cat	No.	Model	Size/Capacity
C2866	31400	12" SPUD Wrench	

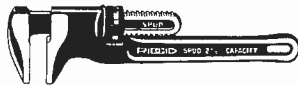

Handy general utility monkey wrench. Designed for efficient working balance and strength but with narrow jaws for easier use in close quarters. Replaceable drop forged heat-treated hook jaw. Special malleable I-beam handle, handy hang-up hole.

### HEAVY-DUTY PIPE WRENCH

Mfrs. Code No. 785461

Cat	No.	Size	Capacity
C2855	31010	10"	1-1/2"
C2856	31015	12"	2"
C2857	31020	14"	2"
C2858	31025	18"	2-1/2"
C2859	31030	24"	3"
C2860	31035	36"	5"



The original heavy-duty pipe wrench, known for its serviceability. Replaceable jaws are mad of hardened alloy steel. Full floating hook jaw gives instant grip release. Handy pipe scale and large easy-to-spin adjusting nut allow fast, one-hand setting to pipe size. Comfort grip, malleable iron I-beam handle.

### END PIPE WRENCH

Mfrs. Code No. 785461

Cat	No.	Size	Capacity
C2861	31055	E-8	1"
C2862	31060	E-10	1-1/2"



Designed with an offset jaw and longer handle swing to ease work in tight places, these wrenches offer the quality features of famous RIDGID Straight Pipe Wrenches: replaceable jaws, full floating hook jaw, easy-spin adjusting nut, pipe scale and malleable iron I-beam handle.

## RIDGID

### STRAIGHT PIPE WRENCH

Mfrs. Code No. 785461

Aluminum Handle

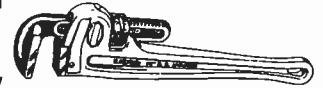

Cat	No.	Model	Size/Capacity
C2863	31095	814	14" 2"
C2864	31100	818	18" 2-1/2"

Aluminum handles make these heavy-duty wrenches almost 40% lighter than similar wrenches with malleable iron handles. Parts are identical to those of RIDGID Straight Pipe Wrenches. Ideal for over head work. Also available with special hook and heel jaws for plastic pipe.

### BASIN WRENCHES

Mfrs. Code No. 785461

1. No. 1010 has solid 10" shank.

2. No. 1017 and No. 1019 have

four-position telescopic shanks for 10" thru 17".

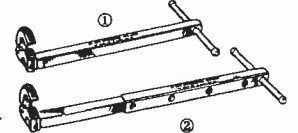

Cat	No.	Model	Size/Capacity
-----	-----	-------	---------------

C2871 31175 1017 10"-17" 3/8" - 1-1/4" nuts

C2872 31180 1019 10"-17" 1-1/4" - 2-1/2" nuts

Forged alloy jaws are spring loaded to grip all nuts 3/8" through 1-1/4" across flats (No. 1010 and No. 1017). You get fast, one-hand ratcheting operation in tight spots. Tension plug holds head in any position up to 90° angle. Handle and shank are chrome plated. Stainless steel spring assures firm grip after positioning jaw on nut, pipe or tube. Telescopic shank on No. 1017 and No. 1019 is quickly adjusted to desired length and held there by spring loaded pin.

### NO. E-110 OFFSET HEX WRENCH

Mfrs. Code No. 785461

Cat	No.	Model	Size/Capacity
-----	-----	-------	---------------

C2865 31305 E-110 2-5/8" Up thru 1-1/2"



Extra wide opening offset jaw gives easy-on, non-slip grip on sink and tube drain nuts . . . all other hard to get at nuts and fittings. Thin, smooth jaws slip into tightest places. Short handle makes work easy in close quarters. Multisided grip allows extra leverage.

### TUBING CUTTERS

Mfrs. Code No. 785461

Internal, Three models for cutting 1-1/4" thru 4" copper and plastic tubing.

Cat	No.	Model	Description
-----	-----	-------	-------------

C2899 83240 108 Internal Tubing Cutter with single handle and one E-2558 cutter wheel.

C2890 83295 109-P Internal Tubing Cutter with two handles and one E-5299 cutter wheel.

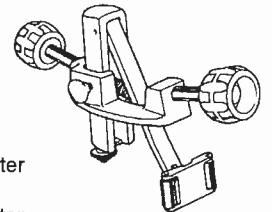

The nos. 108, 109, and 109-P provide a faster and easier method of trimming extended ends off installed closet bowl or shower waste lines below flange level. These cutters feature pearlitic malleable iron frames, convenient swivel roller guides and adjustable wheel frame for capacity and depth of cut adjustment and comfort grip handles. Each cutter uses a hardened cutter wheel for long wear and clean cuts.

No. 108 is designed to trim 1-1/4" thru 2" copper tubing to a depth of 1/4" to 1-3/4".

No. 109-P is designed specifically for cutting plastic waste lines 2-1/2" thru 4" and 1/4" to 2-1/8" depth.

### NO. 456 TRI-BENDER

Mfrs. Code No. 785461

Cat	No.	Model	Size/Capacity
C2885	44852	456	1/4", 5/16", 3/8"

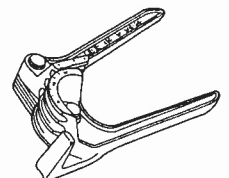

The new Tri-Bender is designed to easily bend three different sizes of tubing: 1/4", 5/16" and 3/8" with the same tool. A 90° start angle minimizes the effort required to form a bend. Handy reference marks indicate angles for quick bends through 90°. The Tri-Bender is made from aluminum and is less than 9" long.

250

**DROP HEAD  
RATCHET THREADERS**

Mfrs. Code No. 785461  
Nos. 00-R & 12-R Exposed Ratchet

Cat	No.	Model	Description
C2874	38540	00-R	Ratchet & Handle Only
C2891	38555	12-R	Ratchet & Handle Only
	36340	00-R	1/2" thru 3/4"
	36345	00-R	1/2" thru 1"
	36355	00-R	3/8" thru 1"
	36365	00-R	1/4" thru 1"
	36375	00-R	1/8" thru 1"
	36480	12-R	1/2" thru 1-1/4"
	36490	12-R	1" thru 2"
	36475	12-R	1/2" thru 2"
	36495	12-R	1/4" thru 2"
	36505	12-R	1/8" thru 2"

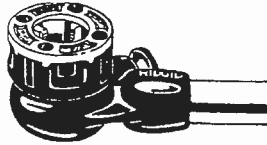

Usually handy, efficient drop-head dies. Head locks in or releases by pull of ratchet knob. Separate sets of alloy steel chaser dies, quickly removed or reversed for close-to-wall threads. Unless otherwise specified NPT dies are furnished. NPSM straight dies and BSPT dies are available.

**DIE HEADS COMPLETE FOR 00-R, 12-R**

Cat	No.	Model	Capacity
C2875	36885	00-R	3/8"
C2882	36890	00-R	1/2"
C2883	36895	00-R	3/4"
C2884	36900	00-R	1"
C2892	37405	12-R	1-1/4"
C2892	37410	12-R	1-1/2"
C2894	37415	12-R	2"

**REPLACEMENT  
DIE SETS  
AVAILABLE  
CALL FOR  
INFORMATION!**

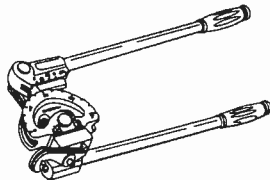

**BENDERS**

Mfrs. Code No. 785461  
300 Series Lever-Type Tube

Cat	No.	Model	Capacity
C2834	36962*	310	5/8" O.D. tube, 2-1/4" radius

*\*Dual purpose product both inch and metric.*

300 Series Lever-Type Benders are designed to bend soft copper tubing to a maximum of 180° with bend ratios of 3.5 (radius/O.D.) or greater to prevent tube wrinkling. 90 start angle maximizes leverage and minimizes bending effort. Features tubular handles with cushion grips and a built-in vise grip.



**ALUMINUM LEVEL**

Mfrs. Code No. 785461

Cat	No.	Model	Description
C2900	36557	624PRO	24" 1" x 2-3/16"

Rust and warp proof extruded aluminum, milled to close tolerances for accurate leveling. Vials are matched for professional accuracy, and locked in a durable truss-constructed body. Yellow fluid increases visibility. Protective acrylic window covers are easily removed for cleaning or replacement.

**TORPEDO LEVEL**

Mfrs. Code No. 785461

Cat	No.	Model	Description
C2901	36130	390M	9" 5/8" X 1-1/4"

Ideal for general use and work in tight places. Three vials for plumb, level, and 45° miter. Made of precision-milled cast aluminium. Model No. 390M is magnetized for metal work and easy storage.



**RIDGID.**

**AUTOMATIC LOCKING  
STEEL TAPES**

Mfrs. Code No. 785461  
Blade Locks Where You Want It,  
Rewinds Automatically

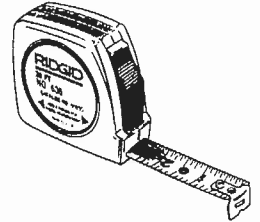

Cat	No.	Model	Description
C2913	36045	636	3/4" 16'
C2911	80295	638	3/4" 20'
C2912	90260	670	3/4" 25'

Chromium plated inside-outside case has button control for locking and power rewinding of tape. Removable belt clip. Tempered steel blade is finished in white enamel and coated with Mylar® for lasting protection. Self-adjusting inside-outside end hook. Stud marks every 16 inches. Replaceable blade.

**HEAVY-DUTY  
SIDE CUTTING PLIERS**

Mfrs. Code No. 785461

Cat	No.	Model	Description
C2918	54025	740	6" Long Chain Nose Pliers

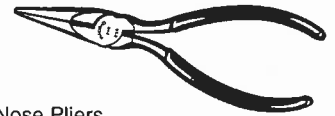

**CUTTER FOR CAST IRON  
NO-HUB® SOIL PIPE**

Mfrs. Code No. 785461

Cat	No.	Model	Description
C2919	68650	206	No-Hub® Soil Pipe Cutter

Lighter weight and closer spacing of cutter wheels gives radial cut on lighter wall pipe. Operation is identical to No. 246 cutter.

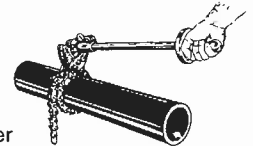

**PHILLIPS STYLE SCREW DRIVER**

Mfrs. Code No. 785461

Cat	No.	Model	Size
C2920	35737	1902	8-3/4" 1/4" X 4"
C2921	35742	1903	11" 5/16" x 6"

Large, easy grip handles, including 11 models with cushion grips. Forged, hardened boron steel blades are bolstered to prevent shaft from being driven back into handle. Blades have precision ground tips, shoulders and flats. Round shanks include hex "wrench location" for added torque applications.



**ROUND SHANK SCREW DRIVER**

Mfrs. Code No. 785461

Cat	No.	Model	Size
C2922	35752	1947	11" 1/4" X 6"
C2925	35767	1950	17-1/4" 3/8" x 12"



**COLD CHISELS**

Mfrs. Code No. 785461

Cat	No.	Model	Description
C2906	93880	1362	Cold Chisel 1/2" x 6"
C2907	93885	1363	Cold Chisel 5/8" x 6-1/2"
C2908	93890	1364	Cold Chisel 3/4" x 7"

Made from chrome alloy steel. Heat treated and drawn to insure maximum durability at the working end and maximum impact resistance at the striking end. Shank is square for easy gripping and prevents tools from rolling off work area. Nickel chrome plated for corrosion resistance. Cold Chisel. Cut cold metal such as brass, bronze, copper, iron, cast iron, aluminum, rivets, nut and bolts.

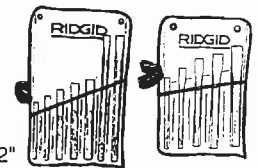

934 S.E. Sixth Avenue • Portland, Oregon 97214 • (503) 235-2167 • (800) 929-5039 • Fax (503) 239-3774

**MIDGET TUBING CUTTERS**  
 Mfrs. Code No. 785461  
 For Up to 15/16" O.D. Tubing  
 In Extreme Close Quarters

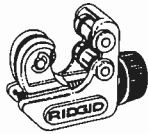

Cat	No.	Model	Capacity	Radius
C2886	40617	101	1/4"-1-1/8" O.D.	2-1/16"
C2887	32975	103	1/8"-5/8" O.D.	1-5/16" max.

These tubing cutters are specifically designed for use in extra close quarters on small size hard and soft copper, aluminum, brass and plastic tubing. Two rollers opposite cutter wheel permit easier rotation and faster cutting. Slide and wheel housing are strong and light weight. Large, knurled feed screw knob gives easy control of cutting pressure for clean-cuts.

**ENCLOSED FEED SCREW TUBING CUTTER**

Mfrs. Code No. 785461  
 Grooved Rollers For  
 Close Flare Cut-Offs

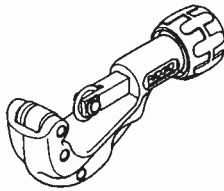

Cat	No.	Model	Capacity
C2895	31622	150	1/8" thru 1-1/8" O.D.
C2889	33055	205	1/4" thru 2-3/8" O.D.

No. 150 and No. 205 feature an enclosed feed screw to eliminate clogging and jamming, grooved rolls for close-to-flare cuts, and a foldaway reamer. No. 205 has a Quick Acting Feed mechanism. Made from high-strength aluminum alloy with a spare cutter wheel in the handle. Cuts copper, brass, and aluminum tubing, and thin-wall conduit.

## RIDGID.

**QUICK-ACTING TUBING CUTTER**

Mfrs. Code No. 785461

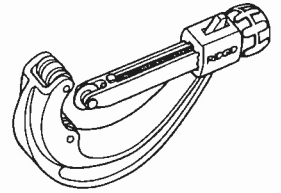

Cat	No.	Model	Capacity
C2896	31632	151	1/4" thru 1-5/8"
C2897	31642	152	1/4" thru 2-5/8"
C2898	36592	153-P	1" thru 3"

"P" Series cutters designed for plastic pipe.

Push the cutter handle to snug the cutter wheel against tubing, press the release nut to automatically snap cutter open. Models 151-156 feature a quick-acting design, I-beam construction, hardened wear surfaces, and thrust bearing slide assemblies for smooth operation. These cutters are available in models for plastic pipe or metallic tubing. Models 151 and 152 feature foldaway reamers.

### NO. 101 TUBING CUTTER

Cat	No.	Model	Description
	1	42312	Wheel Housing
C2844	2	33970	Cutter Wheel Pin & Clip (Include No. 13)
C2839	3	33185	E3469 Cutter Wheel
	4	33955	Stop Pin
C2845	5	34640	Roll (2)
C2846	6	42342	Roller Pin (2)
	7	34750	Screw w/Washer
	8	42337	Knob
	9	42327	Retaining Ring
	10	42322	Feed Screw
	11	42332	Thrust Washer
	12	42317	Roll Housing
	13	74740	Clip

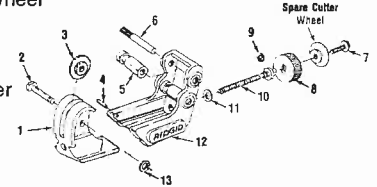

## PIPE AND TUBING CUTTER WHEELS

Cutter Wheels	Tubing Cutters (Original Product)		Cutter Wheel Catalog No.																		Application										
	Model No.	Catalog No.	10	15	20	30	30P	40	40P	50	101	103/104	105/150	106	108	108	109P	131/151	131P/151P	132/152/153		132P/152P/153P	133	133P	134/154	134P/154P	136/156	136P/156P	205	205P	315
	Catalog No.	Model No.	32910	32920	32930	3294C	32945	32955	32960	41527	40617	32975/32985	32990/31622	33005	83240	83290	83295	33015/31632	33020/31637	33025/31642/36597	33030/31647/36592	33035	33040	33045/31652	33050/31657	83185/31662	83235/31667	33055	33065	33075	
	Cat No.	Model No.	10	15	20	30	30P	40	40P	50	101	103/104	105/150	106	108	108	109P	131/151	131P/151P	132/152/153	132P/152P/153P	133	133P	134/154	134P/154P	136/156	136P/156P	205	205P	315	
C2837	33210	E-702	1	.500																											Heavy Wall PVC, ABS
C2842	33165	E-1240	12	.162	✓	✓	✓																								Steel - SS
C2838	33200	E-1740	1	.147																											Soft Flexible Plastic
	74720	E-2155	1	.286															X	X										X	PE, PB, PP, Std. & Heavy Wall
	74730	E-2156	1	.412				X	X														X		X						PE, PB, PP, Std. & Heavy Wall
	74735	E-2157	1	.500																								X			PE, PB, PP, Std. & Heavy Wall
	33175	E-2191	6	.292			✓	✓																							Steel Tubing
C2843	33170	E-2558	6	.220			X	X						X	X	X						X		X		X					Aluminum & Copper
	83235	E-2880	1	.747																											PE, PB, PP, Std. & Heavy Wall
	33205	E-2990	1	.112																										X	Steel, Aluminum Copper
C2839	33185	E-3469	12	.149							X	X	X					X	X										X		Aluminum Copper
	34695	E-3495	1	.290																											Aluminum
	33190	E-4546	6	.162									✓																		Steel - SS
	33195	E-5272	6	.290																											PVC, ABS, Std. Wall
C2840	33180	E-5299	6	.412				✓	✓								X														PVC, ABS, Std. Wall
C2841	33160	F-158	12	.149	X	X	X																								Aluminum Copper
	88260	E-10279	1	.185																											Thin Wall PVC
	41852		12	.250						X																					Muffler Tail Pipe



**NO. 103 TUBING CUTTER**  
Capacity to 5/8" O.D.

**NO. 104 TUBING CUTTER**  
Capacity to 15/16" O.D.

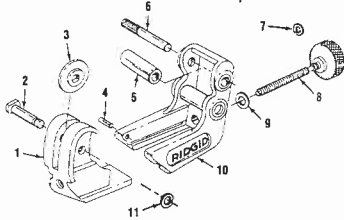

No.	Description	No. 103	Old #	No. 104	Old #
1	Wheel Housing	47342	E-1183	47332	E-1195
*	Wheel Housing (Early Style)	33940	E-1189X	339885	E-1189X
2	Cutter Wheel Pin & Clip	<b>C2844</b>	E-1189X	<b>C2844</b>	E-1189X
3	Cutter Wheel	<b>C2839</b>	E-3469	<b>C2839</b>	E-3469
4	Stop Pin	33955	E-1186	33955	E-1186
5	Roll (2)	33965	E-1188	33965	E-1188
6	Roll Pin (2)	33960	E-1187	33960	E-1187
7	Retaining Ring	42327		42327	
*	Retaining Ring (Early Style)	33830	E-986	33830	E-986
8	Feed Screw & Knob Assy.	47322		47317	
*	Feed Screw & Knob Assy. (Early Style)	33945	E-1184X	33980	E-1194X
9	Washer	42332		42332	
*	Washer (Early Style)	33950	E-1185	33950	E-1185
10	Roll Housing	47337		47327	
*	Roll Housing (Early Style)	33935	E-1182	33975	E-193
11	Clip	74740	E-1154	74740	E-1154

\* Early style housings have plated finish.

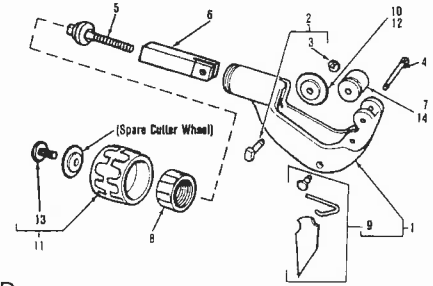

**NO. 105 & 150 TUBING CUTTER**  
Capacity 1/8" thru 1-1/8" O.D.

No.	Description	No. 105	Old #	No. 150	Old #
1	Frame Assembly	33585	D-924-X	33127	
2	Pin and Clip	<b>C2847</b>	E-946-X	<b>C2847</b>	E-946-X
3	Clip	74740	E-1554	74740	E-1554
4	Roll Pin (2)	34355	E-2035	33142	
5	Feed Screw	34630	E-3406	33132	
6	Slide Bar	34635	E-3407-X	33137	
7	Roll (2)	<b>C2845</b>		<b>C2845</b>	
8	Bearing	34645	E-3410	34645	E-3410
9	Reamer Blade Kit	34650	E-3468-X	34650	E-3468-X
10	Cutter Wheel (Thin)	<b>C2839</b>	E-3469	<b>C2839</b>	E-3469
11	Knob Assembly	34740	E-3621-X	33177	
12	Cutter Wheel (H. Duty)	33190	E-4546	33190	E-4546
13	Screw	34750	E-5546-X	34750	E-5546-X
14	Solid Roll (Special)	34765	E-5577	34765	E-5577

**TUBING CUTTERS**  
Nos. 151, 152, 153, 154 and 156

**PLASTIC TUBING AND PLASTIC PIPE**  
Nos. 151-P, 152-P, 153-P, 154-P and 156-P

Capacity 1/4" thru 6-5/8" O.D.

No.	Description	No. 151	No. 152	No. 153	No. 154	No. 156
1	Roller (Large)	<b>C2848</b>	<b>C2849</b>	<b>C2849</b>	32102 (2)	32102 (2)
2	Roller Pin	32107 (2)	32112 (4)	32112 (4)	32117 (2)	32117 (2)
3	Frame	32017	32022	32962	32027	32032
4	Stop Pin	33122	32152	32152	32157	32157
5	Latch	51307	51312	51312	51312	51312
6	Latch Spring	34190	34190	34190	34190	34190
7	Latch Pin	41545	78425	78425	51302	51302
8	Cutter Wheel	<b>C2839</b>	<b>C2839</b>	<b>C2839</b>	<b>C2843</b>	<b>C2843</b>
9	Wheel Pin & Clip	<b>C2851</b>	<b>C2851</b>	<b>C2851</b>	32147	32147
10	Clip	74740	74740	74740	34175	34175
11	Slide	32037	32042	32042	32047	32047
12	Slide Spring	32087	32092	32092	32092	32092
13	Bearing		32082	32082	32082	32082
14	Retaining Ring	32162	32167	32167	32167	32167
15	Feed Screw Assy. (Include #14)	41847	32057	32057	32062	32062
16	Roller Small		<b>C2850</b>			
17	Reamer Blade Kit	32172	32172			
18	Reverible Knob (Include #19)	33177	33182	33182		
19	Washer Screw	34750	34750	34750		
20	Thrust Washer				47137	47137

No.	Description	No. 151-P	No. 152-P	No. 153-P	No. 154-P	No. 156-P
	Cutter Wheel	<b>C2838</b>	<b>C2838</b>	<b>C2838</b>	74730	74735

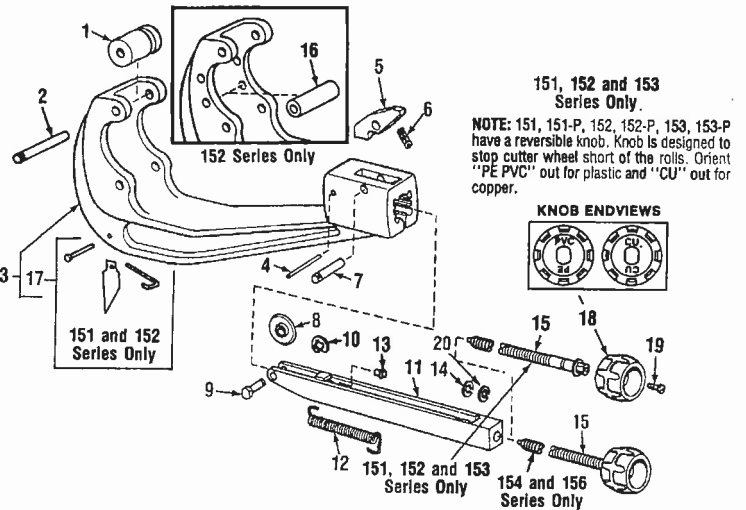

NOTE: Order parts by catalog number only. DO NOT order by reference number.

NOTE: 1. All parts for the P-Series are the same as the Quick-Acting except for those parts listed.  
2. 151-P and 152-P can cut thin wall PVC and flexible plastic when using the 33200 Cutter Wheel.

283

934 S.E. Sixth Avenue • Portland, Oregon 97214 • (503) 235-2167 • (800) 929-5039 • Fax (503) 239-3774



**C1872**  
3/8" CORDLESS  
12 VOLT DRILL  
(0407-6 Kit)

- Includes two batteries, charger and steel carrying case
- Two Finger Variable Speed Switch**  
With electric brake for enhanced control immediately stops rotation with release of trigger switch. Increased control for driving screws and drilling.
- Planetary Gear System**  
Smooth, efficient torque transmission through planetary gear system. Produces up to 195 in./lbs. torque.
- In Line Design**  
Forward drilling pressure is in line with center axis of drill bit for efficient and comfortable drilling.
- Comfortable Hand Grip**
- Excellent Balance**
- 6 Clutch Positions**
- Two Speed Ranges**  
0-1000 rpm for general purpose drilling and screw driving. 0-350 rpm when extra torque is required to drive large screws.



**C1874**  
**MAGNUM®**  
**HOLE-SHOOTER**  
Heavy-duty (0234-1)  
• 0-850 rpm; 5.4 amp motor  
• 1/2" Capacity  
• Trigger speed control, reversing  
• Quik-Lok cord-easy detachment  
• Exclusive quick charge brush cartridge system  
• All ball and roller bearings  
• Heavy-duty industrial chuck

**SELF FEED BITS**

- Hex Shank
- C1927** - 1"
  - C1917** - 1-1/8"
  - C1918** - 1-1/4"
  - C1919** - 1-3/8"
  - C1920** - 1-1/2"
  - C1921** - 1-3/4"
  - C1922** - 2"
  - C1923** - 2-1/8"
  - C1925** - 2-1/4"
  - C1924** - 2-9/16"
  - C1926** - 3-5/8"
  - C1912** - Feed Screw (Pilot Bit)

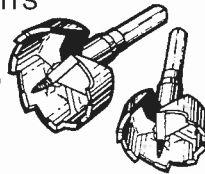

**C1879**  
**HOLE-HAWG®**

- Heavy-duty (1670-1)
- Single speed - 900 rpm
  - Handles up to 2-9/16" selffeed bit

**C1871**  
**HOLE-HAWG®**

- Heavy-duty (1675-1)
- Two speed - 300 and 1200 rpm
  - Handles up to 4-5/8" selffeed bit
  - Reversing, 7.5 amp motor
  - Triple gear reduction
  - Powerful, yet compact for large hole drilling between joists/studs

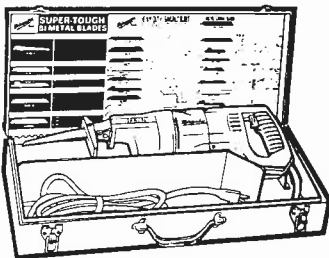
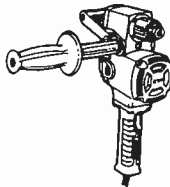

**C1876**  
**SAWZALL®**  
Heavy-Duty (6511)

- Includes 7 piece Bi-Metal blade assortment, socket wrench and holder, extra blade clamp/screw, and steel carrying case.
- Two speeds - 2400 or 1700 rpm.
- High speed for roughing in wood and low speed for metal cutting.
- Handle designed for greater operator comfort and control.
- Rear positioned cord for easier plunge cutting.



**SHIP AUGER BITS**

- C1909** - 1" X 6"
- C1910** - 1-1/8" x 6"
- C1911** - 1-3/8" x 6"
- C1913** - 3/4" x 18"
- C1914** - 1" x 18"
- C1915** - 1-1/8" x 18"
- C1916** - 1-3/8" x 18"

**C1873**  
**SUPER SAWZALL®**  
Heavy-Duty (6528)

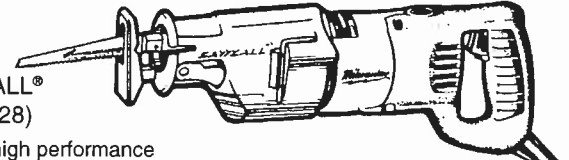

- Fast, smooth, high performance
- Patented counterbalance mechanism reduces vibration for extra smooth operation.
- Long 1-1/4" blade stroke
- Patented show release lever easily adjusts show without tools.
- Dual range variable speed - 0-2000 spm and 0-2800 spm.
- Includes 7 high performance Super Sawzall Blades, hex key, extra blade clamp/screw and steel carrying case.
- Patented rubber boot is designed for operator comfort.
- Reversible blade for cutting upside down.

## ZOELLER CO.

**C1973**  
**MIGHTY MATE**  
"53/55" Series (M53)

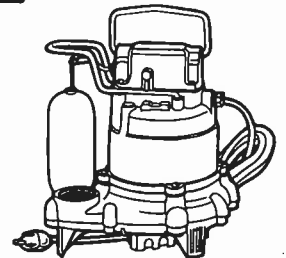

**C5534**  
**DRAIN PUMP (105)**  
Fits under many sinks.  
18" x 18" Basin

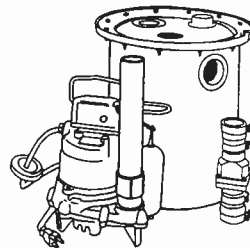

**C1976** - 1-1/2"  
**C1975** - 2"  
**UNICHECK**  
Check Valves

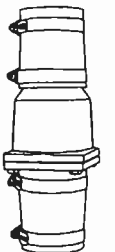

**C1974**  
"WASTE-MATE"  
267 Series  
Non-Automatic

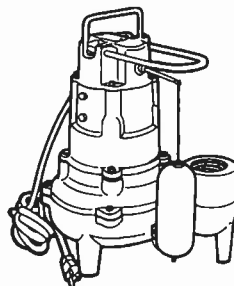

30-0151  
CAST IRON

**WE ALSO STOCK:**

- Piggy Back Floats
- Alarm Systems
- Poly Sump Basins

**CALL FOR MORE INFORMATION!**

**General Wire Spring Co.**



**FLOODGUARD**  
C2795 - 2"  
C2796 - 3"

**GENERAL HANDSNAKE**  
C4331  
1/4" X 25'

**CLOSET AUGERS**  
C4329 - 3' Economy  
C2793 - 3' Contractor w/drop head  
C2794 - 3'-6' Heavy-Duty Extended Auger w/drop head



**ECONOMY HAND TOP SNAKES**  
C4332 - 1/4" X 15'  
C4333 - 1/4" X 25'

**PROFESSIONAL TOP SNAKE**  
No. 10 Container  
C5531 - 1/4" X 25'

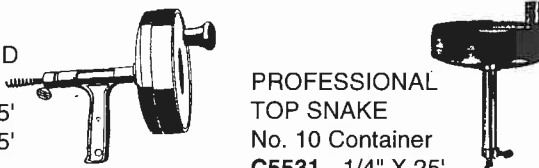

**CANVAS DRAIN FLUSHER**  
C2798 - 1-1/2"  
C2799 - 2-1/2"  
C2804 - 3"  
C2805 - 4"

**REPLACEMENT CABLES**  
C2800 - 1/4" X 25'  
C2806 - 1/4" X 50'  
C2801 - 3/8" X 25'  
C2803 - 3/8" X 35'

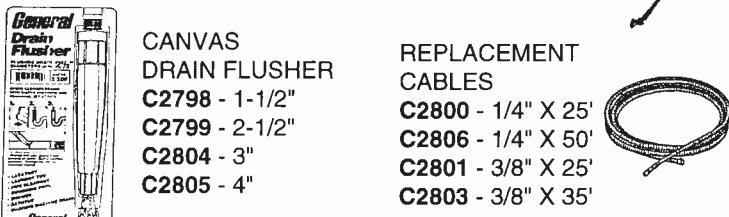

**SUPER-VEE**  
C2814 - GEN SV-A-WC  
With 1/4" x 25' cutter set  
C2815 - GEN SV-B-WC  
With 1/4" x 25' & 3/8" x 35' cutter set

**Case Included!**

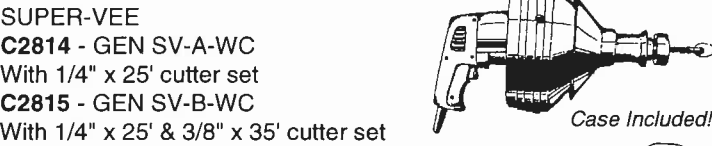

**C2809 MINI-ROOTER**  
Both with 3/8" x 75' cable

**C5532 SELFEEED MINI-ROOTER XP**

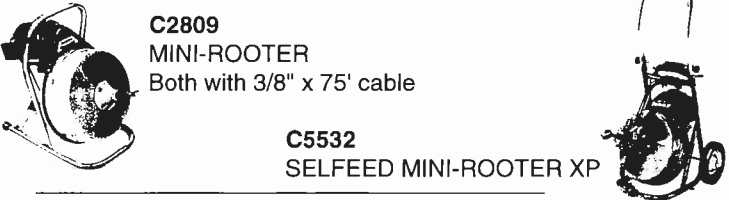

**3/8" CUTTERS, ACCESSORIES**



AH - Arrow Head Starting Drill

C2807 BG - Boring Gimlet-For removing loose objects  
C2808 Same with drop swivel

C2797 1-1/2UC / 1-1/2" "U" Cutter-For cutting and scraping

C2802 SCB Side Cutter Blades (2-piece set) 2"  
For cutting and scraping furnished in 2", 3" & 4" sizes

RSB - Rotary Saw Blades (2-piece set)  
For roots and other stoppages. Furnished in 3" & 4" sizes

RTR-1 - Corkscrew Retrieving Tool  
For removing loose objects

2UC - 2" "U" Cutter - For cutting and scraping

DHF - All Purpose Down Head Fitting  
Converts above cutters to down head style

C2902 - Long handle round point  
C2903 - D-handle sharp shooter  
**PREMIUM GRADE WOOD HANDLE SHOVELS**  
• Lacquered ash handle  
• Premium blade

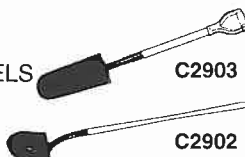

C2903  
C2902

**CHANNEL LOCK PLIERS**

C6801	415	T&G Plier - 10" Smooth Jaw
C2914	426	T&G Plier - 6-1/2"
C2915	430	T&G Plier - 10"
C2916	440	T&G Plier - 12"
C2917	460	T&G Plier - 16"



**CHAN NEL LOCK**

**C6895 RAYOVAC INDUSTRIAL FLASHLIGHTS**  
• Yellow flashlight with ring hangers  
• 2 Cell D size batteries

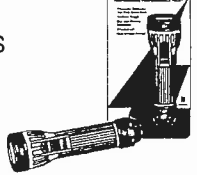

**ELECTRICAL EXTENSION CORDS**  
• UL approved • Round construction  
• OSHA approved orange color

C185	12/350'	Pow-R-Block
C186	12/3100'	Pow-R-Block
C6868	18/225'	Trouble Light

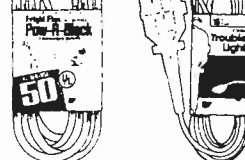

**RAYOVAC HEAVY DUTY ALKALINE INDUSTRIAL BATTERIES**  
C6867 - AA alkaline batteries  
C6869 - D alkaline batteries



**DISHWASHER HOSE - Heavy Duty Rubber**  
C4590 - 5/8" x 50'  
C4591 - 7/8" x 50'

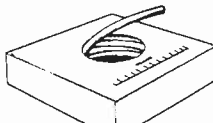

**RUBBER BUNGEE CORD STRAP**  
C2752 - 31"



**GLOVES**  
C4588 - Brown cotton jersey  
C4597 - Leather palm low safety cuff



**C6896 - 1" WIRE BRUSH**  
• For cleaning rough surfaces  
• Polished hardwood handle  
• Stiff steel wire bristle



**C276 - One gallon can WET-R-DRY ROOFING CEMENT**  
• All-weather plastic  
• Chemically fortified to bond to water-covered, damp or dry surfaces  
• Great for emergency repairs under wet conditions.



934 S.E. Sixth Avenue • Portland, Oregon 97214 • (503) 235-2167 • (800) 929-5039 • Fax (503) 239-3774



## DEPENDABLE DRAIN AND SEWER CLEANING TOOLS

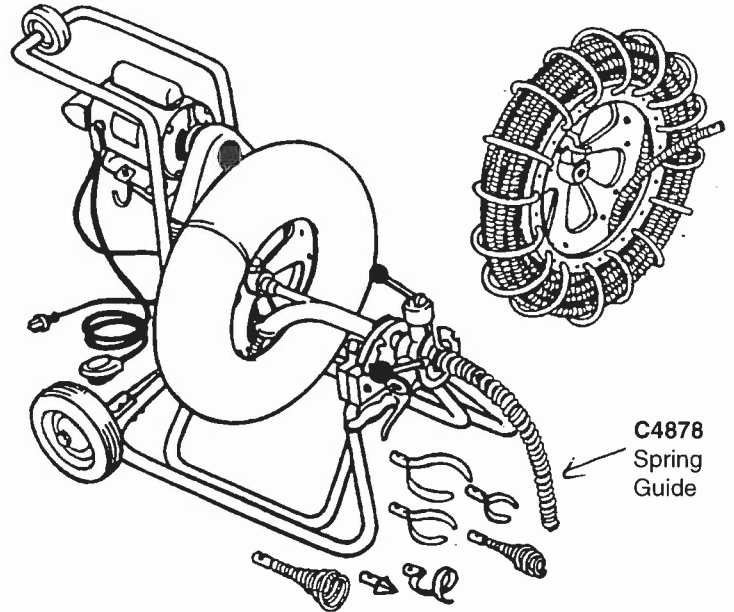

POWERFEED 80 MODEL

C4907 Drum Only

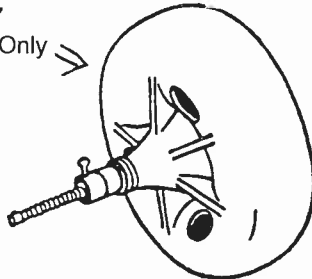

C4875 Drum Pak 1250 1/2" x 50 ft.



C1/2"-C5/8" HUNTER HEAD

C4878 Spring Guide

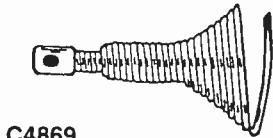

C4869 NO.24 RETRIEVER HEAD



C4885 C3/8" Bore Head

C4879 C1/2"-C5/8" Bore Head

C4894 C5/16" Bore Head



SCREW-ON BULBOUS HEAD

C4873 1/4 Drop Head

C4877 3/8 Drop Head



1/2" SCREW-ON BULBOUS HEAD

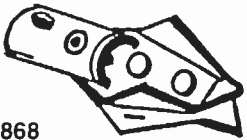

C4868 NO.23 SPEAR FIN

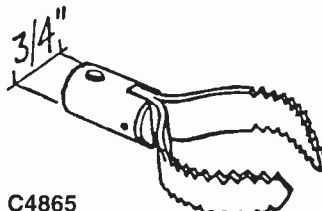

C4865 NO. 20 3" Cutter

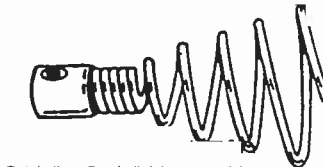

C1/2" - C5/8" Hunter Head

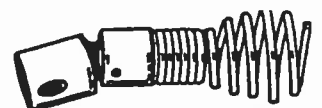

C4896 5/16" Drop Head

C4888 C3/8" Drop Head

C4880 C1/2"-C5/8" Drop Head

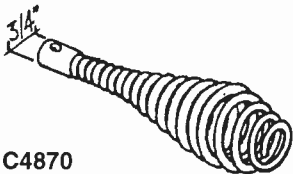

C4870 NO. 25 Auger Head

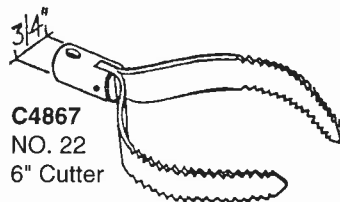

C4867 NO. 22 6" Cutter

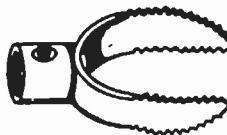

#2 CUTTER BLADE

C4895 5/16" Cutter Blade

C4864 1/2" Cutter Blade

C4886 3/8" Cutter Blade

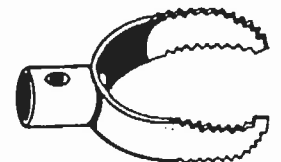

C4871 #3 Cutter Blade

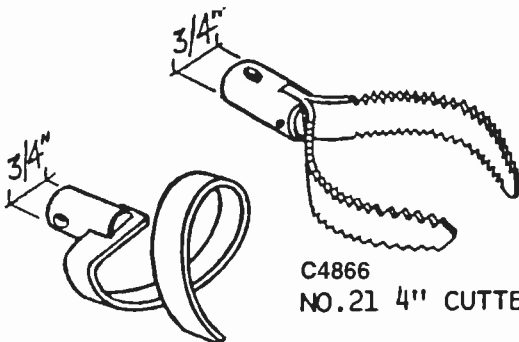

C4866 NO.21 4" CUTTER

C4872 NO.307 ROOT CUTTER BLADE



C4862 NO. 1 CUTTER BLADE



**SPLICE COUPLING**  
C4889 3/8"  
C6903 3/4"

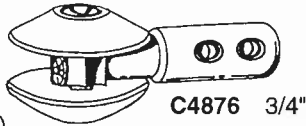

C4876 3/4"

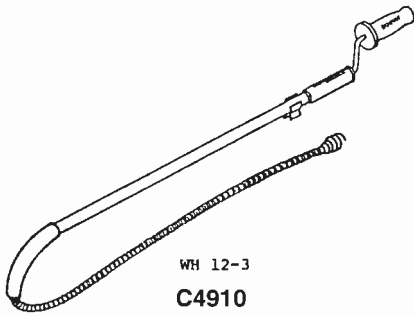

WH 12-3  
C4910

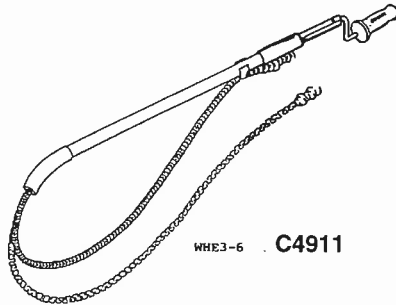

WHE3-6 C4911

- C4897 5/16" x 25'
- C4890 3/8" x 25'
- C4891 3/8" x 35'
- C4892 3/8" x 50'
- C4893 3/8" x 75'
- C4881 1/2" x 50'
- C4882 1/2" x 75'
- C4899 5/8" x 50'
- C4883 3/4" x 50'
- C4884 3/4" x 75'

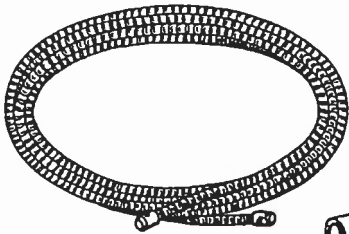

C4874 1/4" x 25'  
Core Refill with Drop  
Head Screw On

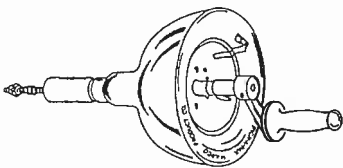
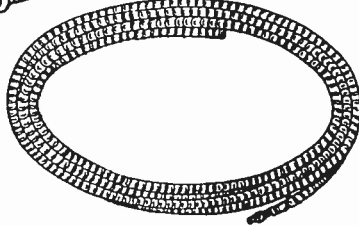

C4905 MP1500 1/4" x 15' Cable  
C4906 MP2500 3/8" x 25' Cable

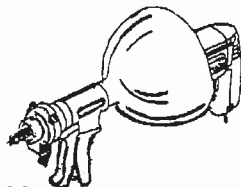

C4904  
Epac Powerfeed  
w/3/8 x 25' Core Cable

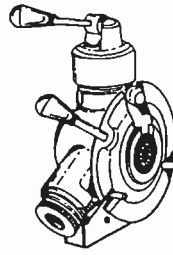

DUALFEED

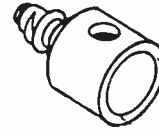

C6901  
3/4" Female Coupling

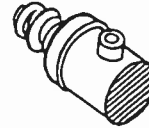

C1/2" Male Coupling  
C4887 C3/8" Male Coupling  
C6902 C3/4" Male Coupling



C4903 CL26 "Snap-Lok" Drop



C4901 CL25 "Snap-Lok" Crawl

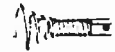

C4900 CL24 "Snap-Lok" Crawl

**CHERNE PRODUCTS**



C4860  
CHERNE Hand Pump  
with Gauge

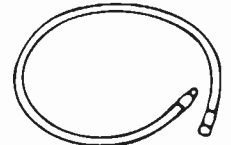

C4858 - 2'  
C4859 - 3'  
TEST EXTENSION HOSE

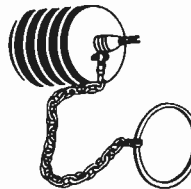

RUBBER INFLATABLE  
TEST PLUG  
C4851 - 1-1/4" - 1-1/2"  
C4852 - 2"  
C4853 - 3"  
C4854 - 4"

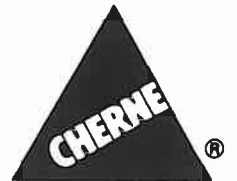

LONG TEST PLUG  
C4855 - 2"  
C4856 - 3"  
C4857 - 4"

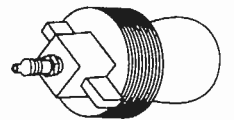
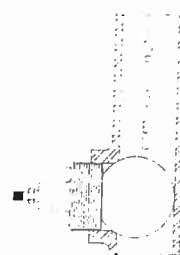
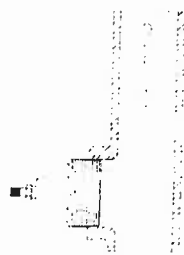
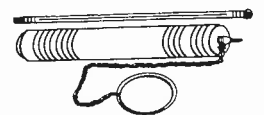

CHERNE CLEAN-SEAL  
Inflatable Test Plug  
C5522 - 2"  
C5523 - 3"  
C5524 - 4"

934 S.E. Sixth Avenue • Portland, Oregon 97214 • (503) 235-2167 • (800) 929-5039 • Fax (503) 239-3774

### GRAPHITE TWIST PACKING

Graphite Twist Packing; Speedy® Twist Packing Of:



#### C4351

Graphite Twist Packing, Asbestor Free - 1/4 lb, 1/8" diameter.

#### C4352

Graphite Twist Packing, Asbestos Free - 1/4" diameter.

## DRAIN CLEANING CHEMICALS

### CLOROBEN PT-4

C3295 - Quart Size

C3293 - Gallon Size

Flow improver and waste liquefier.

- Biodegradable. Non-acid/Non-caustic.
- Emulsifies (liquefies) grease, soap, fat & detergents.
- Concentrated - One gallon makes five gallons.
- Non-corrosive to metals, non-fuming.
- Reduces or eliminates regular grease trap cleaning.
- Harmless to digestive bacteria when used as directed.



### DRAIN SNAKE

C3288 - Quart Size

C3290 - 1/2 Gallon Size

Sulfuric acid based liquid drain opener

FOR PROFESSIONAL USE ONLY.

- NOT FOR RETAIL SALE OR FOR USE BY HOUSEHOLDERS!
- Opens emergency clogs.
- Disintegrates paper, cloth, sanitary napkins, food scraps, and other organic matter.
- For drains, traps, toilets, urinals, waste lines.
- Dependable and fast acting.
- Contains corrosion inhibitors.



### OPEN WIDE

C3292 - 1 lb. size

A powerful powdered drain opener for use by home owners and professionals alike.

- Formulated from powerful alkalies and oxidizing agents.
- Dissolves soap and hair build-up. • Controls odor.
- Self dissolving with lower heat generation and less fuming than other powdered drain openers.
- Suitable for all plumbing fixtures, plastic piping, and septic systems.
- May also be used for bowl cleaning and deodorizing.



### CLOROBEN DE - (NOT SHOWN)

C3291 - Quart Size

Hydrochloric (muriatic) acid based delimer, descaler, & all-purpose cleaner.

- Disintegrates concrete, plaster, and grout in drains and traps.
- Dissolves lime, rust, scale, urinary salts, and minerals.
- Contains inhibitors and foam reducers.

SUGGESTED USE: For treatment of condenser coils, hot water heaters, and other plumbing, heating, and cooling equipment as well as waste lines. Also can be used as an industrial strength bowl cleaner.



### HAIR AWAY

C268 - Quart Size

An Alkali containing drain cleaner.

## CHEMICALS AND COMPOUNDS



### CLEAR PVC CEMENT

C234 - 4 oz.

C235 - 8 oz.

C236 - 16 oz.

C237 - 32 oz.



### "RAIN-R-SHINE"

Blue PVC Cement

C238 - 16 oz.



### WHITE ABS CEMENT

C233 - 32 oz. only



### TEFLON

PIPE JOINT COMPOUND

C252 - 8 oz.

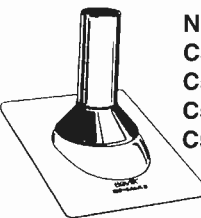

### NO-CALK ROOF FLASHINGS

C5518 - 1-1/2"

C5519 - 2"

C5520 - 3"

C5521 - 4"

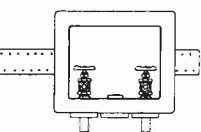

### ICE MAKER BOXES

White

C247 - For Copper

C5525 - For Flowguard Gold CPVC

### WASHING MACHINE BOXES

White

C248 - For Copper

C5526 - For Flowguard Gold CPVC

# Oatey



### BLACK ABS CEMENT

C229 - 4 oz.

C230 - 8 oz.

C231 - 16 oz.

C232 - 32 oz.



### PURPLE PVC PRIMER

C239 - 4 oz.

C240 - 8 oz.

C241 - 16 oz.



### PIPE JOINT COMPOUND

C251 - 16 oz.

### TELESCOPING GLUE

APPLICATOR

C5514

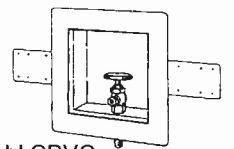
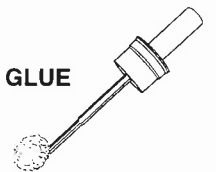

**COMPOUNDS, CHEMICALS, PUTTY**



C6992 1.7 oz.  
C1968 8 oz.  
C1969 16 oz.  
**NOKORODE**  
Water Flushable Paste Flux

C6888  
**TEMPORARY REPAIR**  
OF OIL & GAS LEAKS



**PIPETITE STIK**  
Reg. Size C1942  
King Size C6887



**EPOXY PUTTY**  
C4826  
4 oz. tube



C4824  
**TEFLON PIPE**  
1 Fl. oz.  
Thread Compound



C4825  
**PIPE THREAD**  
2 oz.  
Compound



C1944  
**SLIC-TITE STIK**  
1 1/2 oz.  
Thread Compound  
with Teflon

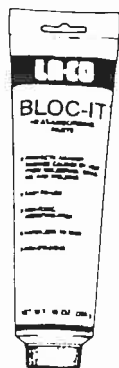

C1935  
**BLOC-IT**  
Heat Absorbing  
Paste. Protects  
Rubber & Plastic  
Parts in Valves  
While Soldering

**HEAT-PRUF GREASE**  
Lubricates faucet stem threads, O-ring packings, gaskets, ballcock cup leathers, etc.

Part No.	Size	Per Case
C2321	2 1/2-oz.	12
C2322	1/2-oz.	10

**LAN-LIN® HAND CLEANER**

C2326  
14 oz.  
"RUB IT ON...  
RINSE OR WIPE  
IT OFF!"  
Gets hands REALLY clean. Gets down deep into skin crevices and removes grease, paint, grime and dirt. Leaves hands soft...helps prevent chapping. Use with or without water.



**TOILET SEAT HINGE BOLTS**  
C4829

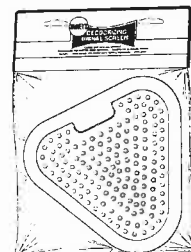

C4830  
**DEODORIZING URINAL SCREEN**

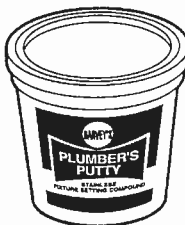

C1937 14 oz.  
C1938 5 lbs.  
**PLUMBER'S PUTTY**



C1936 1/2 pt.  
**SILICONIZED PIPE JOINT COMPOUND**  
Handy Brush in Cap



C534 1/2 Pint  
C6991 Pint  
**RECTORSEAL #5**



C1939 4 oz. Paste  
C1940 1 lb. Paste  
**WATER-SOLUABLE FLUX**



C1945 1/4 pt.  
C1941 1/2 pt.  
C1947 1 pt.  
**THREAD SEALING PASTE**  
With Teflon. Handy Brush in Cap

C1948 3/32" X 25'  
C1949 5/32" X 20'  
**PACKING & GASKET SEALANT CORD**  
Withstands Temperatures -450°F to +550°F

