

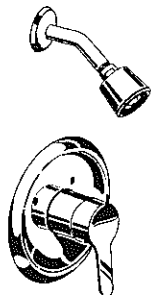

RELIANT +

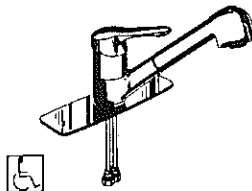

- C402** .002 Polished Chrome
- C403** .099 Polished Brass
- PRESSURE BALANCE SHOWER ONLY FITTING**
- Direct sweat inlets
- Metal lever handle



- C425** .002 Polished Chrome
- C6208** .020 White
- RELIANT+ COMBI**
- Combi Body and Spray with
- 1/2" male threaded connectors and nuts
- Escutcheon plate is included (Use is optional)



- C404** .002 Polished Chrome
- C405** .099 Polished Brass
- PRESSURE BALANCE BATH/SHOWER FITTING**
- Direct sweat inlets
- Slip-on diverter spout
- Metal lever handle

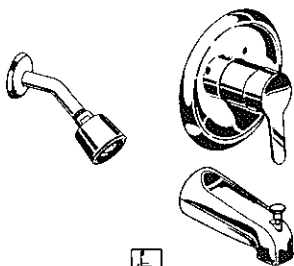

- C6209** .002 Polished Chrome
- C427** .020 White
- KITCHEN FAUCET**
- Metal handle
- With spray
- 1/2" male threaded connectors and nuts

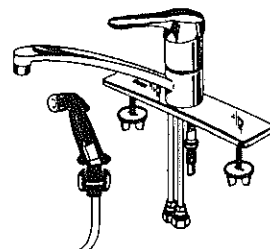

- C426** .002 Polished Chrome
- KITCHEN FAUCET**
- Metal handle
- Less spray
- 1/2" male threaded connectors and nuts

CERAMIX

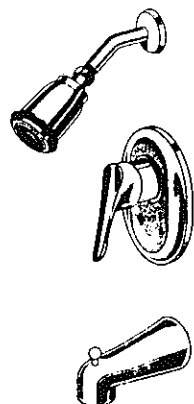

- C409** .002 Polished Chrome
- C410** .020 White
- C6200** .099 Polished Brass
- PRESSURE BALANCE SHOWER ONLY FITTING**
- Spool type, includes check stops
- Brass showerhead

- C411** .002 Polished Chrome
- C412** .099 Polished Brass
- PRESSURE BALANCE BATH/SHOWER FITTING**
- Spool type, includes check stops
- Brass diverter spout
- Brass showerhead



CERAMIX

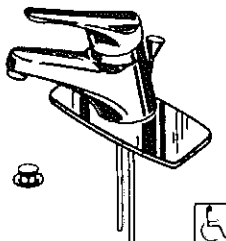

- C406** .002 Polished Chrome
- C407** .020 White
- C408** .099 Polished Brass
- LAVATORY FAUCET**
- 3/8" O.D. copper inlets
- Pop-up drain
- Escutcheon plate



CERAMIX

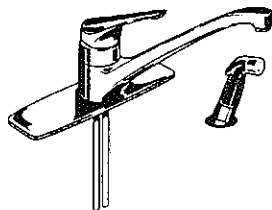

- C417** .002 Polished Chrome
- C419** .020 White
- KITCHEN FAUCET**
- Cast brass spout
- Separate spray
- Optional Escutcheon plate
- 3/8" O.D. copper inlets



RELIANT +

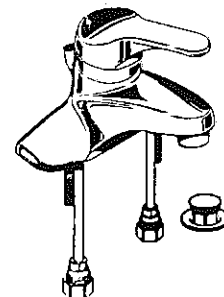

- C421** .002 Polished Chrome
- C6201** .020 White
- C422** .099 Polished Brass
- LAVATORY FAUCET**
- Metal pop-up drain
- 1/2" male threaded copper connectors and nuts
- Metal lever handle

- C423** .002 Polished Chrome
- LAVATORY FAUCET**
- Less pop-up drain, less pop-up hole
- 1/2" male threaded copper connectors and nuts
- Indexed metal lever handle

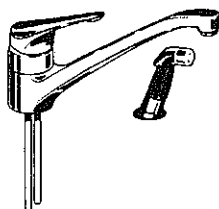

- C420** .002 Polished Chrome
- KITCHEN FAUCET**
- Cast brass spout
- Less spray
- With spray
- 3/8" O.D. copper inlets

934 S.E. Sixth Avenue • Portland, Oregon 97214 • (503) 235-2167 • (800) 929-5039 • Fax (503) 239-3774

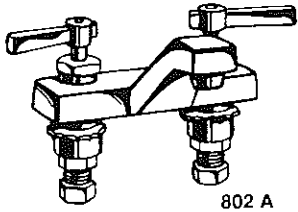

C6213
No. 802A. Hi-Lite Quatum fitting with No. 369 handles, 4" spout and No. E12 Softflo aerator.



C6341

No. 895. Hi-Lite Quatum fitting with No. GN-1A-E3 rigid/swing convertible gooseneck spout, No. E3 Softflo aerator and No. 369 handles.

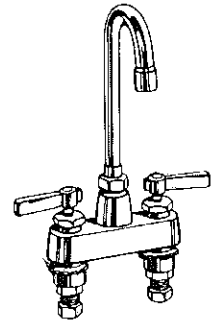

C6212

No. 802A-333-SLO. Naiad push button slow closing faucet with renewable operating units 4" spout and No. E12 Softflo aerator.

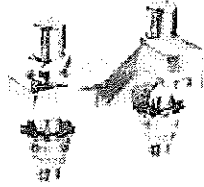

**C6240 (Cold)
C6241 (Hot)**

No. 333-E12-SLO. Naiad push button self closing basin faucet with No. 333-27K slow-closing dashpot and No. E12 Softflo aerator on outlet.

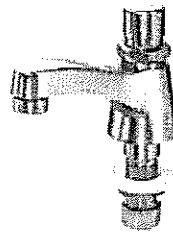

C3017
No. 50-E3. Double pantry sink fitting with No. GN-2A-E3 rigid/swing, convertible gooseneck spout, No. E3 Softflo aerator and No. 369 handles. Furnished 3 1/2" centers.

C3037

No. 445. Hi-Lite Quatum sink fitting with No. 369 handles, No. S6 swing spout, No. E3 Softflo, and No. H 1/2" flanged female supply arms. Body inlets 3 3/8" centers. Supply arms adjustable from 4" to 8 3/8" centers.

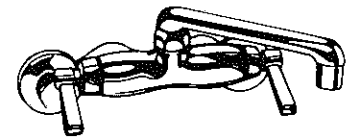

C6214

No. 349. Single Quatum pantry sink fitting with No. S6 swing spout, No. E3 Softflo aerator and No. 369 handle.

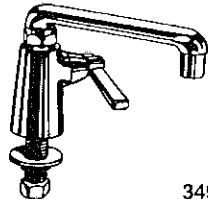

349

**C3026 #305VBRCP
C3027 #305VBRR.C.F.**

No. 305-VB-R. Same as No. 305-VB except with "R" integral stop arms. Body inlets, 3 3/8" centers. Supply arms adjustable from 4" to 8 3/8" centers. Also furnished in polished chromium plate.

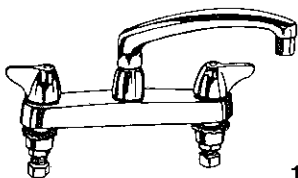
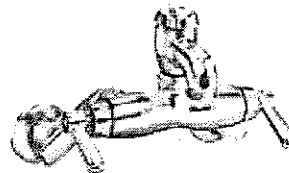

1100

C3058

No. 1100. Classic Quatum top mount deck sink fitting with No. L8 8" swing spout, No. E3 Softflo aerator, No. 1000 handles. Inlet shanks on 8" centers.

**C3012 (Cold CP)
C3013 (Hot CP)**

No. 7. Polished chromium plated. Short pattern, male with shoulder and with No. 369 handle 3/4" male inlet, 3/4" hose thread outlet.

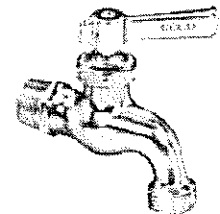

C3033 (Cold)

No. 335-E12. "Tip-Tap" slow-closing single basin faucet with No. 333-27K slow-closing dashpot and E12 Softflo aerator on outlet.



C6216 CP

No. 540 LD. Hi-Lite Quatum straight 8" sink fitting, No. 369 handles, No. S6 swing spout, No. E3 Softflo, and No. G 1/2" flanged female supply arms. Body inlets 8" centers. Supply arms adjustable from 7 1/4" to 8 3/4" centers.

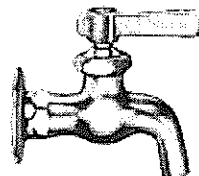
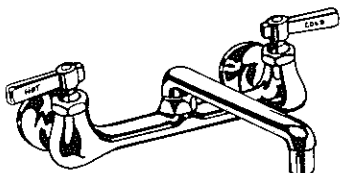

**C3014 (Hot CP)
C3015 (Cold CP)**

No. 12. Polished chromium plated. Short pattern, flanged female, and with No. 369 handle 1/2" female inlet, plain outlet.

934 S.E. Sixth Avenue • Portland, Oregon 97214 • (503) 235-2167 • (800) 929-5039 • Fax (503) 239-3774

C3045

802A-665CP

Deck Mounted Lavatory Adjustable Metering Faucet

4" Spout with E12 aerator
665 handles on 4" centers, Chrome plated finish

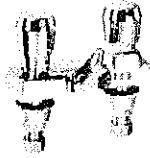

C3031

333-665-Cold CP

C3032

333-665-Hot CP

Metering Single Faucet

E12 Aerator
665 Color coded push handle
Chrome plated finish



C3040

613ACP

Pre-Rinse Add A Faucet

19-9 1/2" Swing spout with E1 outlet
3/8" female outlet for riser
Inlet thread fits faucet body outlet
Chrome plated finish

C3030

332CP

Wall Mounted Single Water Faucet

S6 Swing Spout
E3 Aerator
369 Handle indexed cold, 1/2" I.P.S. Female inlet

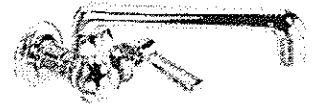

C3036

404ACP

Deck Mounted Lavatory Faucet on 8" Centers

5" Spout with E12 aerator
633 handles, Chrome plated finish



C3029

327ACP

Grid Strainer Waste

Non-removable brass strainer
Integral Spud with 1 1/4" tailpiece
Chrome plated finish



C3016

45CP

Straight Valve

1/2" Female inlet and outlet, 633 handle
Chrome or rough chrome plate

C3055

919CP

Deck Mounted Pre-Rinse

36" stainless steel hose with no.80 sprayhead
23" riser with hose hook and pipe support
Check tailpieces, Chrome plated finish



C3018

80CP

Pre-Rinse Spray Head

Rubber bumper spray outlet, Chrome plated finish



C6340

919S

PRERINSE RISER SPRING, HOSE, & SPRAY VALVE ONLY



C3019

81CP

Pre-Rinse Angle Spray Head

Rubber bumper spray outlet
Chrome plated finish



C3061

1967CP

Deck Mounted Lavatory Fitting

Integral Rose spray outlet
950 handles on 4" centers
with 1/2" I.P.S. male inlets
Chrome plated finish

C3028

324-669CP

Push Button Metering Sink Fitting

E3 Aerator, 669 Push Handle,
Chrome Plated Finish

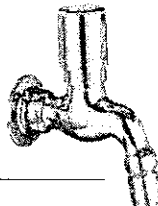

C3043

748-669CP

Self-Closing Bubbler

.7 GPM Stedi-Flo on shank
669 handle, Chrome plated finish

C3059

1201ACP

Concealed Deck Mounted Kitchen Faucet

L8-8" Swing spout with E3 aerator
1000 handles on 8" centers, Chrome plated finish

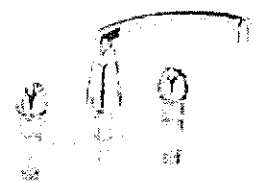



C6215 RCF

C3024

No. 293. Sill faucet, 1/2" inlet flanged female, with 3/4" hose thread on outlet, with lock shield cap and No. 293-6 removable tee handle. Rough chromium plated. Also furnished in polished chromium plate.

No. 387. Same as No. 293 except with 3/4" flanged female inlet. Rough chromium plated. Also furnished in polished chromium plate.

**C3053 CP
C3054 RCF**

No. 897. Combination service sink fitting with vacuum breaker, with 3/4" hose thread on spout, No. 369 handles, wall brace, pail hook, and No. R 1/2" flanged female adjustable arms with integral stops. Polished chromium plated. Also furnished in rough chromium plate. Body inlets, 3 3/8" centers. Supply arms adjustable from 4" to 8 3/8" centers.

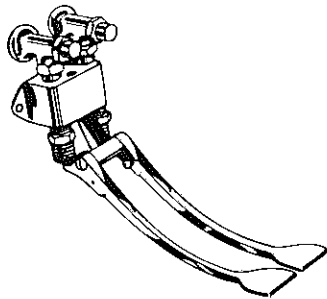
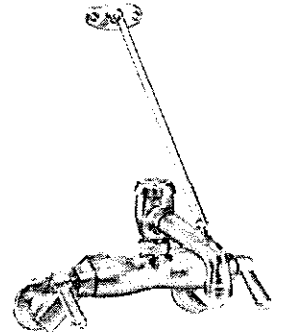

C3046

No. 834 E.P. Wall hung double pedal valve with long pedals, and No. 698 loose key angle stops with straight tailpieces. Center to center of No. 698 valve inlets, 2 1/2". No. 698 valve inlet 1/2" I.P.S. female. Top outlet 3/8" I.P.S. female.

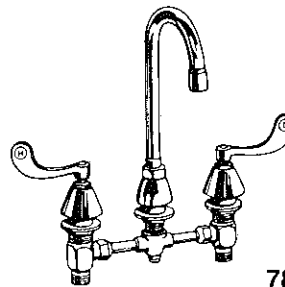

786

No. 786. Hi-Lite Quatern fitting with No. 317-4" wrist blade handles. No. GN-2B-E4 rigid/swing convertible gooseneck spout with No. E4 rose spray.

C3044

No. 786-E3. Same as No. 786 except with No. E3 Softflo aerator.

C3041

No. 625. Double pedal valve. Two back inlets, one back outlet, mixing type. Inlets are tapped 1/2" I.P.S. and outlet is 3/8" I.P.S. Polished chromium plated. Also furnished in rough chromium plated finish.

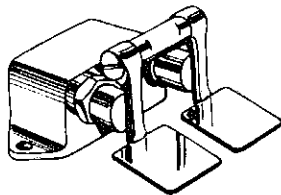

C6217

No. 786-WC-E3. Same as No. 786 but with swivel valve body connectors on 12" centers. For wheel chair lavatories. No. E3 Softflo aerator.

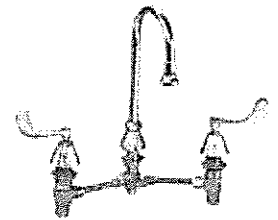

C3106

No. 628. Single pedal valve with one 1/2" I.P.S. female back inlet, one 1/2" I.P.S. female top outlet. Polished chromium plated. Also furnished in rough chromium plated finish.

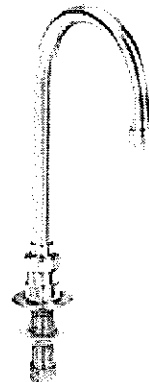

C3042

No. 626-E3. Gooseneck spout, for lavatory use, with No. GN-2A-E3 rigid/swing convertible spout, and No. E3 Softflo aerator. Can be furnished with 1/4" tailpiece at additional cost.

Central Brass

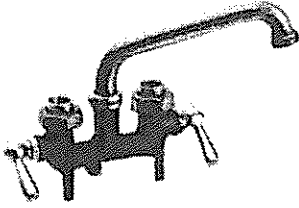

C4960 465

Cast Brass Laundry Faucet on 3½" Centers, with female coupling union connections, 6" tube spout with hose end, straddle legs and rough brass finish.

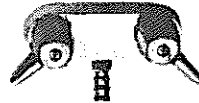

C4936 206

Cast Brass Leg Tub Fitting on 3¾" Centers, ¾" -14NPS male shanks x 1½" long, with front lever handles and polished chrome finish.

- 208 Same as above but with 6¾" high gooseneck spout.

C4937

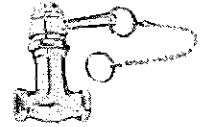

C4951

335½" Self-Closing Cast Brass Shower Stop with lever handle and chain pull and polished chrome finish.



C4966 950

Three-valve Cast Brass Body Assembly only, on 8" Centers; I.P. Unions.

- 958 Same as above with ½" I.P.S. brass spout.

C4968

C4969 with H.A.F. and Tub Spout



C4967 951

Three-valve Cast Brass Body Assembly only, on 11" centers; I.P. unions.

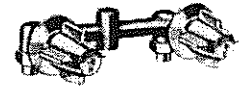

C4965 905

Two-valve Cast Brass Body Assembly only on 8" Centers; I.P. unions.

C6334 w/Brass Tub Spout

C6335 w/SHR Head, Arm & Flange

C6333 w/H.A.F. and Diverter Tub Spout

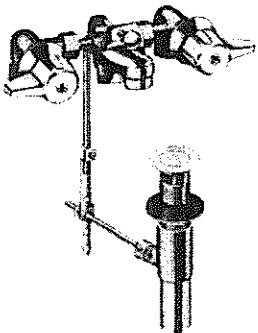

C4974 1177-DA

Shelf Back Faucet with cast brass bodies, centers adjustable from 4" to 6" and pop-up drain.

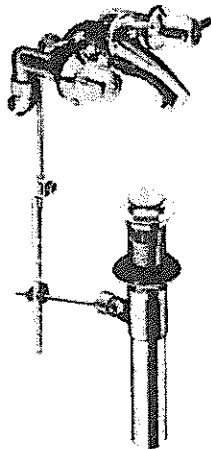

C4975 1178-DA

45° Slant Back Faucet with cast brass bodies, centers adjustable from 4" to 6" and pop-up drain.

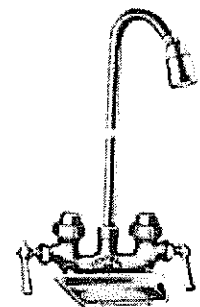

C4963 477-RB

Utility Shower with Cast Brass Body on 3½" Centers, with 22½" high galvanized riser and shower head and soap dish; rough brass finish.

Central Brass

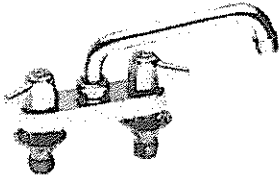

C4930 84
Cast Brass Bar/Laundry Faucet on 4" Centers with 6" tube spout.

C4931
84-GSA
Same as 84 but with gooseneck spout for Bar Sink Application.

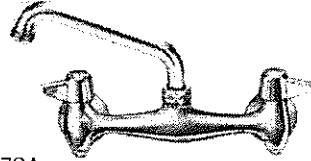

C4925 47SA
Adjustable Inlet 6" Spout.
C4926 47SA
Adjustable Inlet 8" Spout.
C4927 47SA
Adjustable Inlet 12" Spout.
C4928 47UA
Straight Inlet 6" Spout.
C4929 47UA
Straight Inlet 8" Spout.

Wall Mount Sink Fitting on 8" Center with 6" tube spout, replaceable seats and polished chrome finish

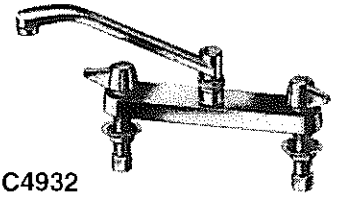

C4932 122
Cast Brass Top Mount on 8" Centers with 8" brass "D" spout.
• 123 Same as 122 but with hose and spray. **C4933**

127 C4934
Cast Brass Top Mount on 6" Centers with 8" brass "D" spout.
• 128 Same as 127 but with hose and spray.
C4935

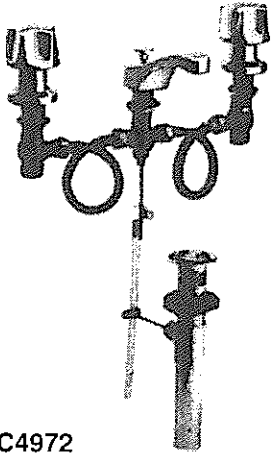

C4938 (Cold)
C4939 (Hot)
239
Solid Cast Brass Basin Cock with solid flange and cross handle.

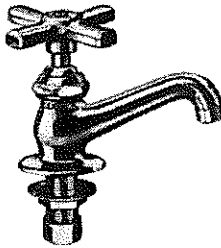

C4972
1125-DA
Widespread with cast brass bodies, flexible hose connections adjustable from 6" to 24" and pop-up drain.

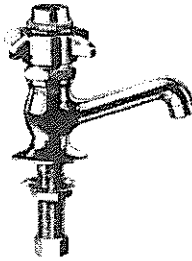

C4940 (Cold)
C4941 (Hot)
255
Self-Closing Solid Brass Basin Cock with solid brass cross handle.

C4973 1137-A Less Popup
C6339 1137-DA
4" Solid Cast Brass Center set with pop-up drain.

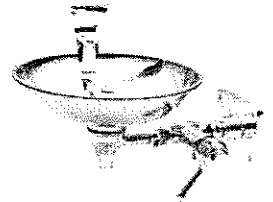

C4957 366-HX-8"WB
Cast Brass Wall Mount Drinking Fountain with brass, brush-finished round bowl, self-closing lever handle, cast brass wall bracket and polished chrome finish.
• 366-HX-8" Same as above but less wall bracket.
C4956



C4952
360
Cast Brass Bubbler Head with 1/2"-14NPS male shank, flange and replaceable cartridge. Polished chrome finish.
• 361 Same as above but with 3/8"-18NPS female thread. **C4953**

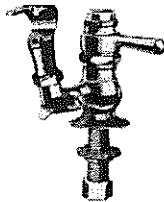

C4954
364-L
Cast Brass Drinking Faucet with 1/2"-14NPS male shank, self-closing lever handle and polished chrome finish.
• 365-L Same as above but with 3/8"-18NPS female thread. **C4955**

C4947 3/8"
C4948 1/2"

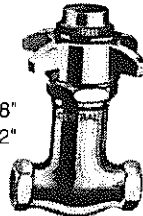

331
Self-Closing Straight Stop with 4-arm handle and polished chrome finish; replaceable seat.
Sizes: 3/8"-18NPS female and 1/2"-14NPS female.

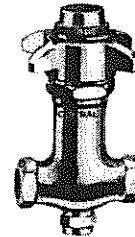

C4949
332 - 3/8"
Self-Closing Straight Stop with Regulator, 4-arm handle and polished chrome finish.

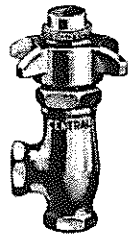

C4950
333 - 1/2"
Self-Closing Angle Stop with 4-arm handle and polished chrome finish; replaceable seat.

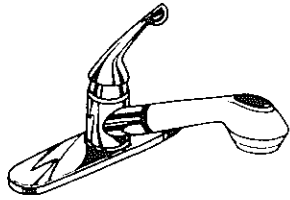

C1036 #462

C1029 #150-WF
C1035 #450
 With spray

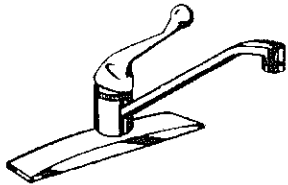
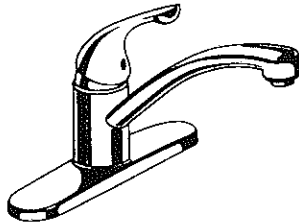

200 C1032
 Wall Mount Kitchen Faucet

100WF C1027
 Single Handle Kitchen Faucet
 8" center, 8" swing spout.
400WF C1034
 With spray.

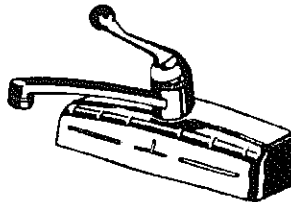

2121 C6253
 Laundry Tub Faucet
2123 C1049
 With out hose thread

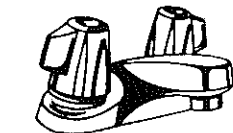

2500 C1051
 4" Centerset Lavatory Faucet
 Blade handles.
2520MPU C-1052
 With pop-up drain.

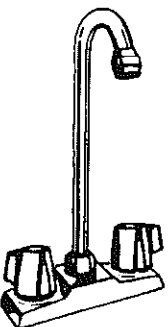

2171 C1050
 Bar Faucet

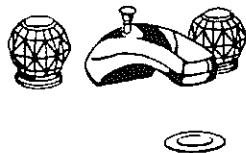

3544WFMPU C6258
 Widespread Lavatory Faucet
 6" to 16" center, pop-up drain.

101WF C1028
 Single Handle Kitchen Faucet
 8" swing spout,
175WF C6251
 With spray.

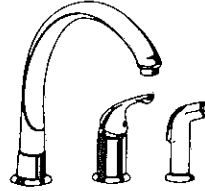
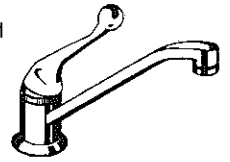

172WF C1030
 Widespread Kitchen Faucet
 9-7/16" high, 9-1/2" long swing spout.

300WF C1033
 Single Handle Kitchen Faucet
 8" center, 8" swing spout, spray.

300DWF C6257
 Same with soap dispenser.

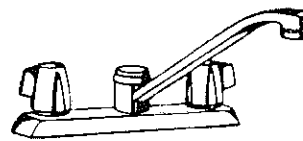
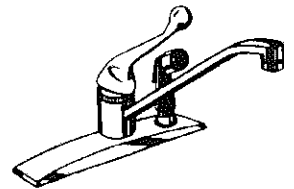

2100 C6255
 Two Handle Kitchen Faucet
 8" center, 8" swing spout.
2400 C6256
 With spray.

2102 C1048
 Two Handle Kitchen Faucet 8" center, 8" swing spout.
2402 C6250
 With spray.

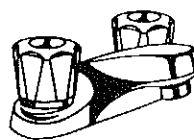
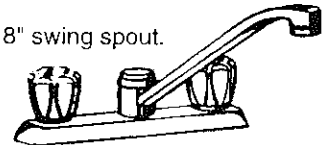

2502 C6254
 4" Centerset Lavatory Faucet, Crystal handles.
2522MPU C1053
 With pop-up drain.

520 C1039
 Single Handle Lavatory Faucet
 4" centerset, lever handle.

501 C1037
 Same less lift rod

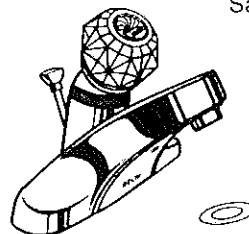
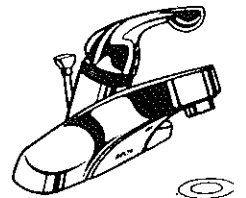

522WFMPU C1040
 Single Handle Lavatory Faucet
 4" centerset, crystal handle.

934 S.E. Sixth Avenue • Portland, Oregon 97214 • (503) 235-2167 • (800) 929-5039 • Fax (503) 239-3774



C1042
601
Conventional Bath Valve
Lever handle.

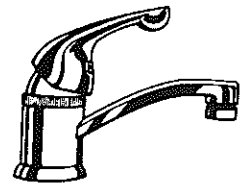

C1041
570
Chrome
Single hole installation

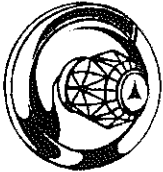

C6259
602
Conventional Bath Valve
Crystal handle.

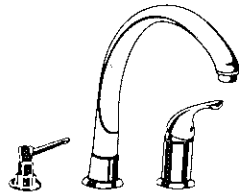

C1031 #173-WF

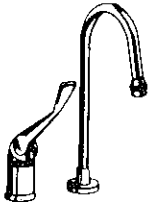

C1044
711-WFHDF
Chrome
Utility Faucet
2 Hole installation

C1045
1348
Chrome
C6260
1324
Less spout

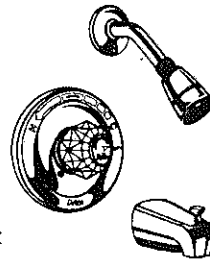

C1047
1548
Chrome
C6252
1504
Valve only

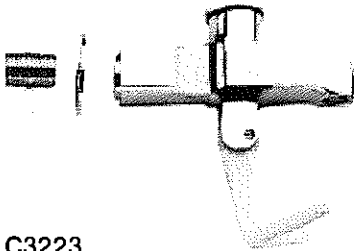
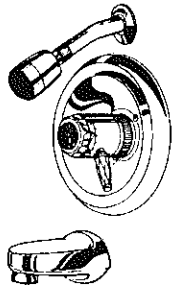

C3223
10200
3/8" Glass Filler head
Close nipple, flange, locking compound
(Replacement head for Fisher and T&S Glass Fillers - replaces
Fisher #1000, #1001, and #1005)

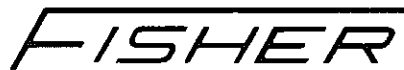

C3255
2990
Standard Spray Valve.



C3221
1007
Glass Filler: 8" pedestal, 3/8" M

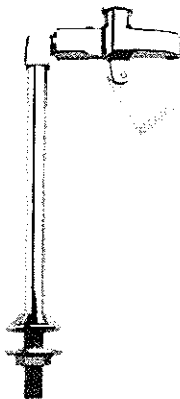

C3222
1010
Same only 3/8" F.

C3253
2928
Spring Type Pre-Rinse
Top Section

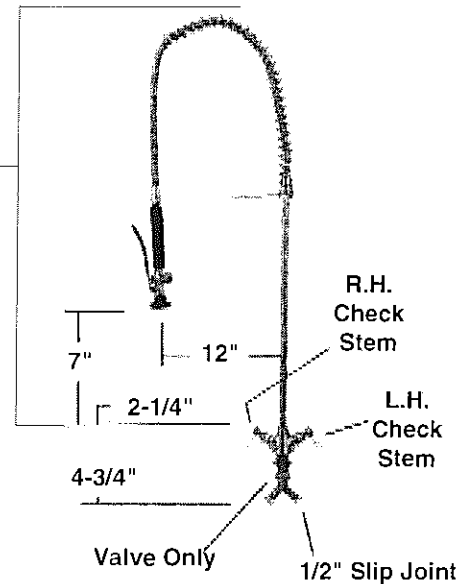

C3241
13080
Valve only with
Internal Check Valves

170

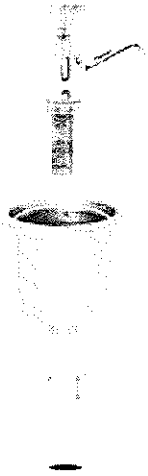

3041 C3259
Combination Dipperwell Faucet,
Sink and 1-1/2" x 4" Tailpiece

3042 C3260
Faucet only

FISHER

NOTE:
We order our
Fisher Faucets in
components, so we
can supply many
more variations for
you. Don't see what
you want?
Call for availability.

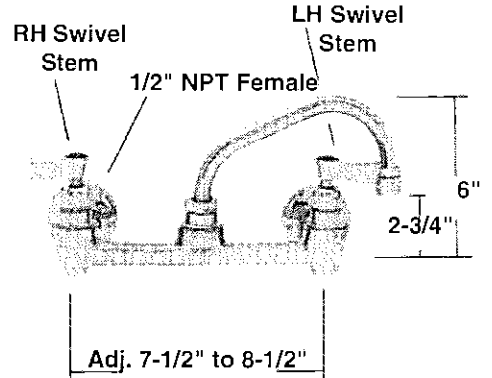

Faucet with 8" Spout. Consists of:
3200 C3262 Wall Mount Valve
3961 C3266 8" Swing Spout

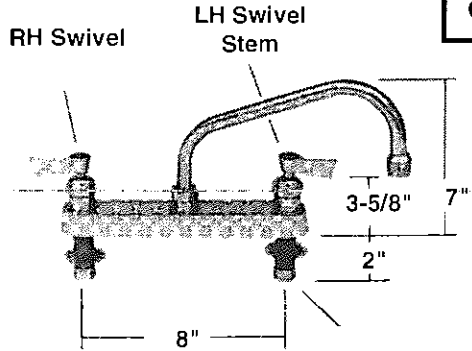

3300 C3263 8" Deck Faucet L/S
3963 C3268 12" Swing Spout

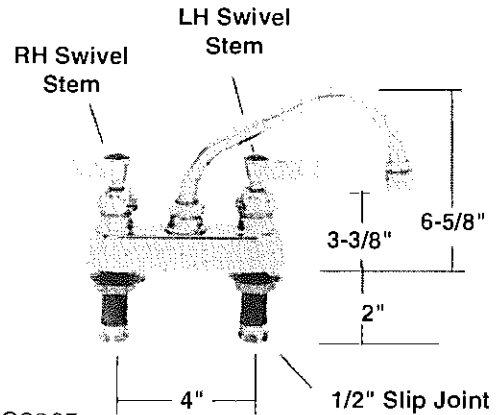

3511 C3265 Faucet with 8" Spout. Consists of:
3500 C3264 4" Deck Faucet L/S
3961 C3266 8" Swing Spout

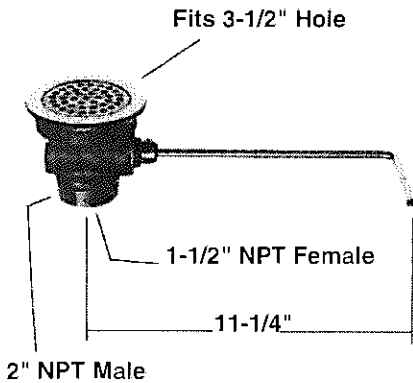

10758 C3226
Rotary Waste Valve with flat strainer.

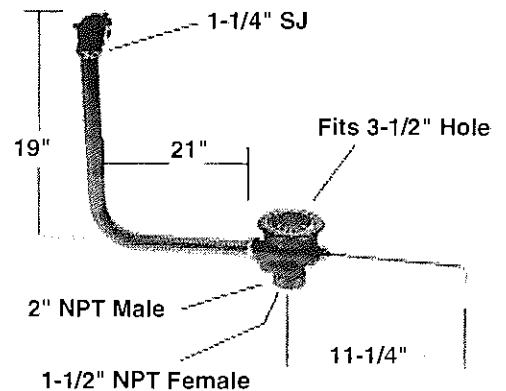

10707 C3225
Rotary Waste Valve with overflow assembly and flat strainer.

INDIANA BRASS



C3204
 Shower Stall Valve with 3-3/8" center

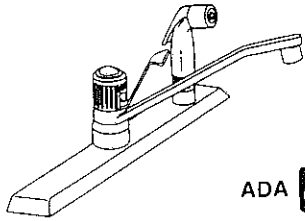

C612
 Models: 7831
 CHATEAU®
 Single-Handle Lever Style
 Kitchen Faucet

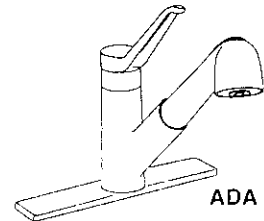

C605, C607, C606
 Models: 7385, 7385W, 7385-C
 OneTouch®
 Single Control Kitchen Faucet
 with Pullout Spray

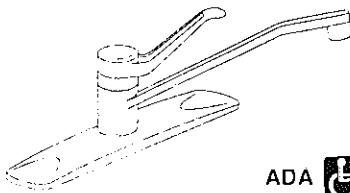

C600
 Models: 7200
 LEGEND®
 Single-Handle Kitchen Faucet

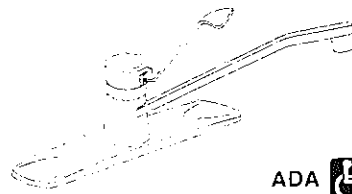

C602
 Models: 7300
 LEGEND®
 Single-Handle Kitchen Faucet

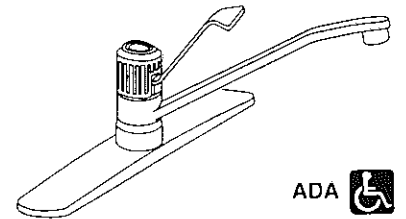

C608
 Models: 7531
 CHATEAU®
 Single-Handle Lever
 Style Kitchen Faucet

C601
 Models: 7210
 With Spray

C603
 Models: 7310
 With Spray

C613
 Models: 7841
 With Spray

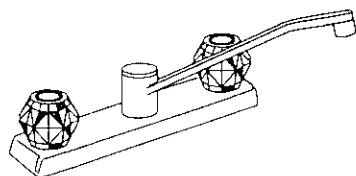

C615
 Models: 7900
 CHATEAU®
 Two-Handle Knob Style Kitchen Faucet

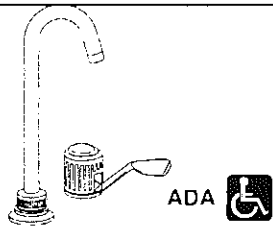

C590
 Models: 4901
 CHATEAU®
 Single-Handle Lever Bar Faucet

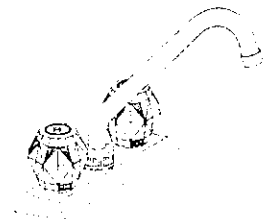

C598
 Models: 4975
 CHATEAU®
 Two-Handle Laundry Faucet

934 S.E. Sixth Avenue • Portland, Oregon 97214 • (503) 235-2167 • (800) 929-5039 • Fax (503) 239-3774

ADA 

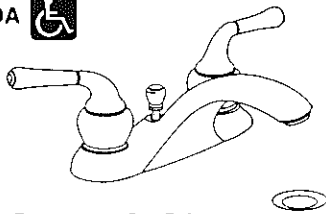

C580, C6958, C581

Models: 4550, 4550CP, 4550P Polished Brass
MONTICELLO™
4" Lavatory Faucet w/Metal Waste Ass.



ADA 

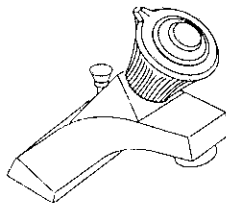

C578

Models: 4220
LEGEND®
Single-Handle Lavatory Faucet
with Metal Waste Assembly

C584, C6961

Models: 4570, 4570CP
MONTICELLO™
Two-handle Widespread Lavatory
Faucet with Metal Waste Assembly
(less handle inserts)
C585 Polished Brass

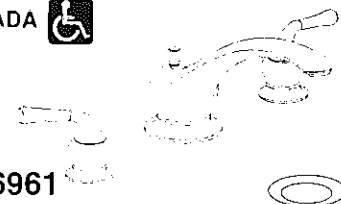

ADA 

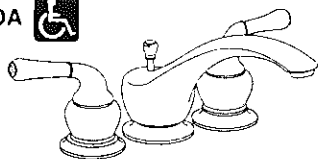

C6959, C6960, C582

Models: 4560, 4560CP, 4560P, 4560W
MONTICELLO™
Two-Handle Lavatory Faucet
(less handle inserts)
with Metal Waste Assembly

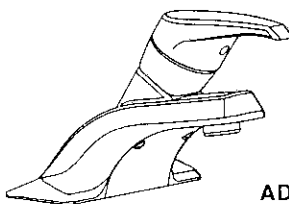

ADA 

C6962

Models: L4601
CHATEAU®
Single-Handle Lavatory Faucet
C589 Models: L4621 with Pop-Up

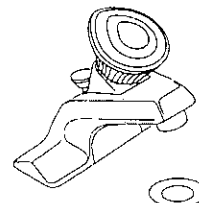

C587, C588

Models: 4621, 4621P
CHATEAU®
Single-handle lavatory Faucet
with Metal Waste Assembly

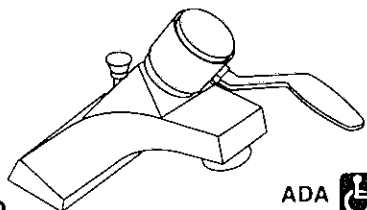

ADA 

C579

Models: 4420
LEGEND®
Single-Handle Lavatory Faucet
with Metal Waste Assembly

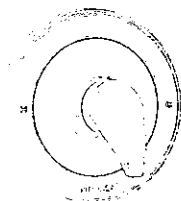

ADA 

C6963

Models: L3170
LEGEND® MOENTROL®
Single-Handle Pressure Balancing
Shower Valve w/Temperature Limit Stop

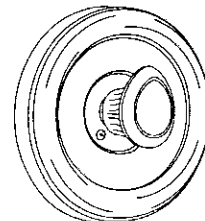

C569

Models: 3179
MOENTROL®
Single-Handle Pressure Balancing
Tub/Shower Valve with Temperature
Limit Stop

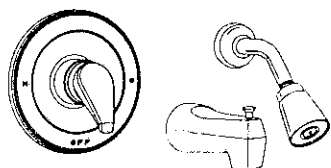

ADA 

C562

Models: L2353
CHATEAU® POSI-TEMP®
Single-Handle Tub/Shower Valve
C560 Models: L2352 Shower Only
C559 Valve Only

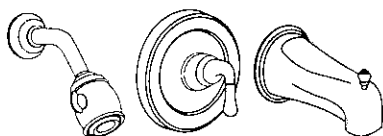

ADA 

C6234, C6236, C6235

Models: 3127, 3127CP, 3127P
MONTICELLO™ MOENTROL®
Single-Handle Pressure Balancing Tub/
Shower Valve w/Temperature Limit Stop
C6231, C6233, C6232 Shower Only

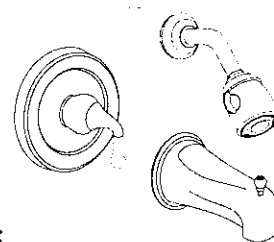

ADA 

C565

Models: 2347
MONTICELLO™ POSI-TEMP®
Single-handle Tub/Shower Valve
C564 Model: 2345 Shower Only

934 S.E. Sixth Avenue • Portland, Oregon 97214 • (503) 235-2167 • (800) 929-5039 • Fax (503) 239-3774



SCOT LAVATORY FAUCET

Slow-Closing Omni Temperature
The metering faucet with temperature selection

C4153



Standard Handle

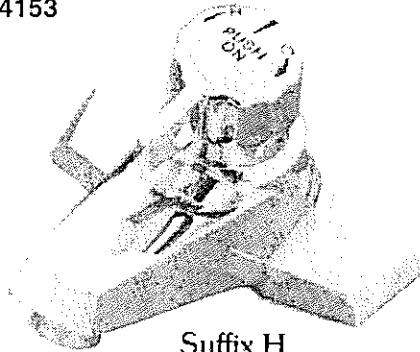

Suffix H
Blade Handle

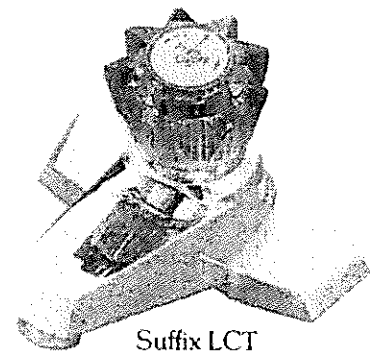

Suffix LCT
Acrylic Knob

S-60-G

Symmons SCOT Metering Temperature Selection Faucet 4" Centerset slow-closing lavatory faucet to meter and mix hot and cold water supply. Temperature limit stop to adjust outlet temperature. Time limit stop to adjust flow time. Rose spray outlet with 0.5 GPM flow rate. Vandal proof. Grid strainer drain assembly.

C4154 - S-60-P

With pop-up drain assembly.

S-60-1

With lift rod only.

S-60

Faucet only.

MODIFICATIONS:

Suffix A: Standard aerator in place of rose spray (with standard aerator flow rate is 1.25 GPM at 50 PSI).

Suffix LCT: Acrylic multifaceted knob.

Suffix QC: For quick-closing feature.

Suffix IPS: With 1/2" IPS connections.

Suffix STE: Supply tube extensions, 8" w/ compression couplings.

Suffix H: Blade type handle for Barrier-Free application.

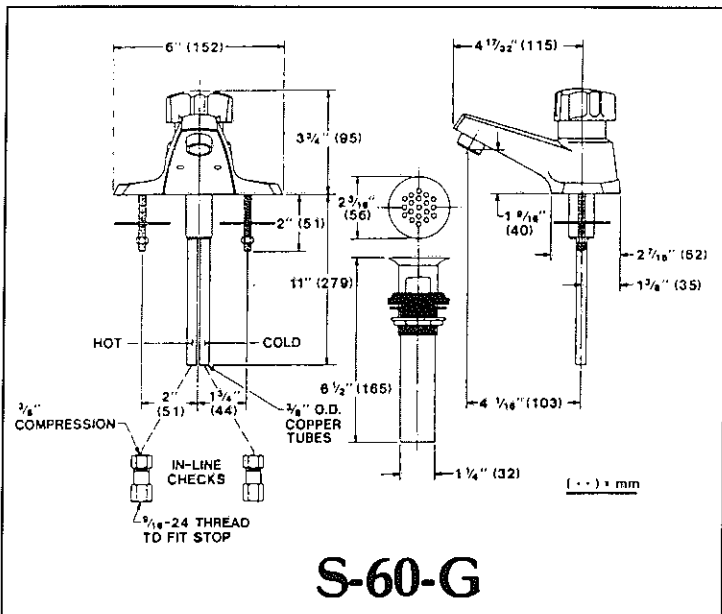

S-60-G

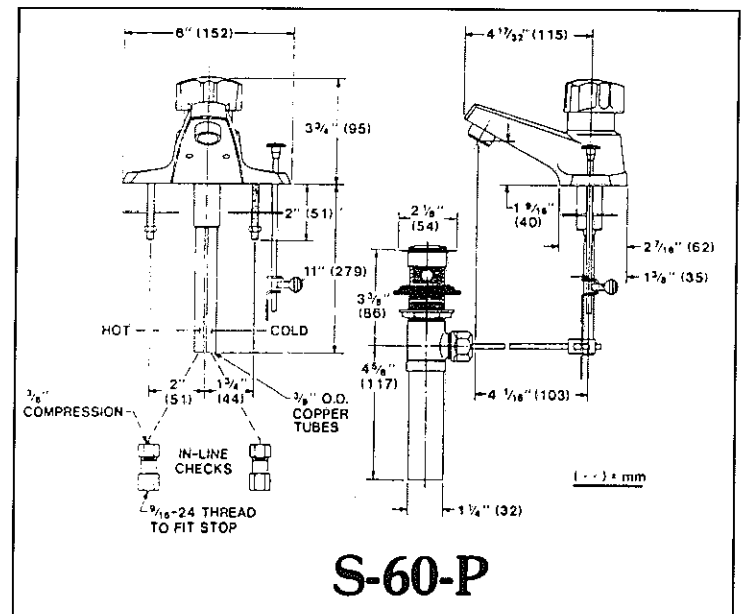

S-60-P

C5960

B-805 Slow Self-Closing Faucet

Heavy duty, push button faucet. Provides adjustable timed flow of water from instantaneous shut off to extended flow by external adjustment. Vandal resistant. 1/2" NPS threaded shank, fits sinks up to 1 3/8" thick. 1/2" O. D. slip inlet. Approximately 5 1/2" high. Center of inlet to aerator outlet is 3 3/4". Outlet 2" above deck.
Specify hot or cold or blank.

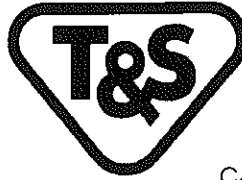
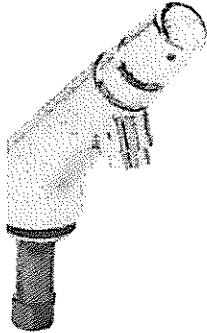

NOTE:
We order these valves less spouts, therefore we can make most any variation for you, call for price and availability.

C4230

B-1100LN Workboard Faucet Less Swing Nozzle

Bronze body with removable seats. High luster chrome plated brass escutcheon 6 1/2" long x 2" wide. Shanks on 3 1/2" centers. 1 1/2" long, 1/2" NPS thread.
Shown with C4206 6" Swing Nozzle

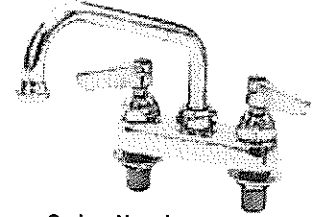

C4235

B-1200 Push-Back Glass Filler

Heavy duty construction. Wall mounted — 3/8" IPS female inlet with adjustable flange. Volume regulator. Center of outlet to wall — 3 3/4". Translucent blue Lexan push-back arm, instantaneous shut-off.

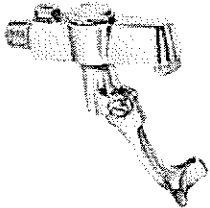

C6089

B-1205 Push-Back Glass Filler

Heavy duty construction. Wall mounted — 3/8" IPS male inlet. Volume regulator. Center of outlet to inlet — 3 1/2". Translucent blue Lexan push-back arm. Instantaneous shut-off.



C6090

B-1210 Pedestal Type Push-Back Glass Filler (Single)

Built for heavy duty, this unit has adjustable flange on shank of pedestal. 1/2" IPS male shank 2" long. Base of flange to outlet — 8" minimum. Volume regulator. Instantaneous shut-off. Translucent blue Lexan push-back arm.

B-155 LN C4238

Add-On Faucet for Use with Pre-Rinse Units

Adds a swinging nozzle faucet to pre-rinse units for dual purpose utility — eliminating separate faucet installation and extra plumbing costs. Operates on same line and water controls as pre-rinse through diverter valve. Any length nozzles can be furnished on request, single or double jointed, for use on any type of sink. This exceptionally versatile combination unit offers a multitude of uses for rinsing, cleaning soaking and filling in kitchen and pantry.

Shown with C4206 6" Swing Nozzle.

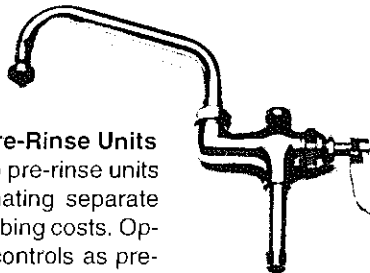

B-220-LN C4255

Deck Mixing Faucet Less Nozzle

8" centers on deck faucet with 1/2" IPS eccentric flanged female inlets. Lever handles.



B-240-LN C4254

Combination Sink Faucet Less Nozzle

Adjustable inlet arms with integral stops — 1/2" IPS female with flange. Arms adjustable from 2 1/4" to 6" centers. Lever handles.

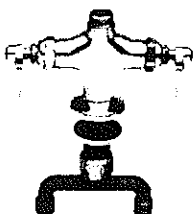
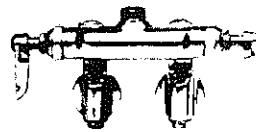

B-200-LN C4239

Double Pantry Facuet Less Nozzle

Lever handles. 1 1/8" diameter shank. 1/4" IPS union type tailpieces on 4" centers.

B-305-LN C4242

Single Pantry Faucet

1/4" IPS union type tailpiece. Lever handle, "C" (or "H").



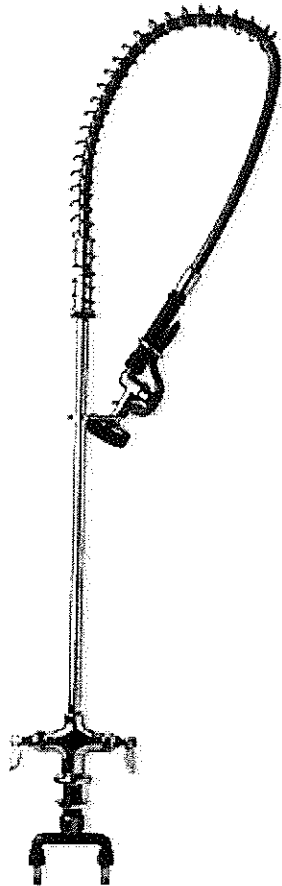
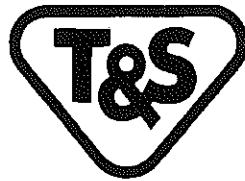

C4233

**B-113
Pre-Rinse Unit**

Complete pre-rinse unit includes a mixing faucet for obtaining correct water temperature. Deck type faucet has under-sink mixing spreader with built-in ball checks and 1/4" IPS tailpiece connections on 4" centers. Spring action type gooseneck gives a wide range of coverage. Unit is approximately 40" high with an overhang of about 15" and with 9" clearance. In normal position, the spray valve hangs approximately 31" below top of the gooseneck spring. Longer length hoses available on request.



C4234

B-114 The "Nautilus"® Pre-Rinse Unit

The ultimate in pre-rinse design and efficiency! This complete pre-rinse unit includes a mixing faucet for desired water temperature. Unit may be used with 180 degree F. water for after-rinse. Unique "roto-flex" swivel joint design provides widest coverage. Spray valve retracts automatically to "idle" position on release. Under sink 1/4" I.P.S. tailpiece connections have 4" centers. Complete assembly is approximately 50" high and has about a 2-foot overhang.

NOTE: Built-in Check Valves:

This unit is furnished with built-in check valves to prevent cross flow of water when pre-rinse spray is closed and mixing faucet is left open.

**SPECIAL
ORDER ONLY**

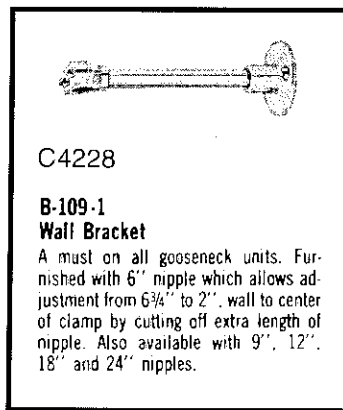

C4228

**B-109-1
Wall Bracket**

A must on all gooseneck units. Furnished with 6" nipple which allows adjustment from 6 3/4" to 2". wall to center of clamp by cutting off extra length of nipple. Also available with 9", 12", 18" and 24" nipples.

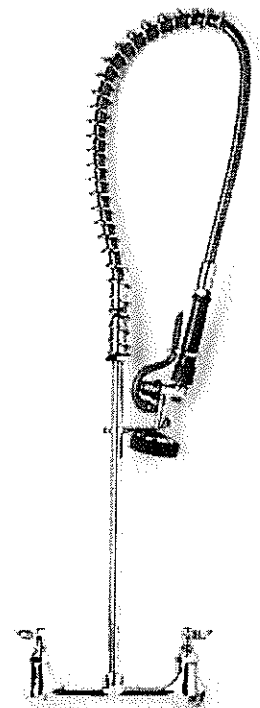

C4237

B-133 Pre-Rinse Unit

A complete pre-rinse unit with mixing faucet to provide the correct water temperature. Assembly is used where a wall of splashback connection is desired. Recommended where it is necessary to have no obstructions on sink top. Faucet has 8" centers with 1/2" IPS female eccentric flanged union inlets. The spring-action type gooseneck gives the user a wide range of coverage. Unit is 34" high with 15" overhang and measures 5" from bottom of spray valve to C/L of faucet. Longer length hoses furnished on request.

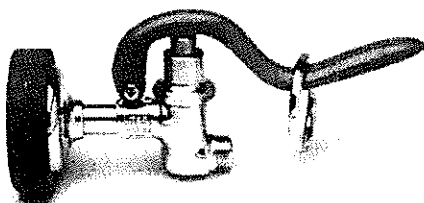

C4227

B-107 Pre-Rinse Spray

Well constructed and versatile spray head designed especially for heavy duty use in industrial kitchens. Provides a high pressure spray when handle is pressed down and shuts off when handle is released.



BADGER 1

C1953

1/3 H.P.

- Continuous feed
- 360° swivel impellers
- Full 1 year parts and in-home service warranty



BADGER 5

C1954

1/2 H.P.

- Continuous feed
- 360° swivel impellers
- Full 1 year parts and in-home service warranty

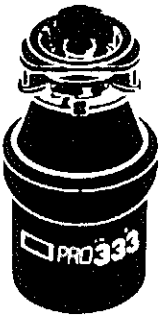

PRO 333

C1955

1/2 H.P., Quiet System

- Continuous feed
- Polished sink flange
- 360° swivel impellers-s.s. grind elements
- Full 3 year parts and in-home service warranty

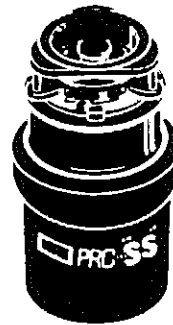

PRO 333/SS

C1956

3/4 H.P., Stainless Steel, Quiet System

- Continuous feed
- Polished sink flange
- 360° swivel impellers-s.s. grind elements
- Full 5 year parts and in-home service warranty

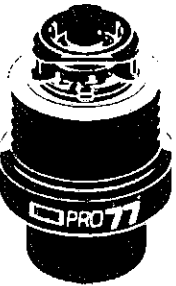

PRO 77

C1957

1 H.P., Stainless Steel, Quiet System

- Continuous feed
- Polished sink flange
- Automatic reversing switch
- Full 7 year parts and in-home service warranty



PRO 17

C1958

3/4 H.P., Stainless Steel

- Lock cover/batch feed
- Polished sink flange
- Automatic reversing switch
- Full 7 year parts and in-home service warranty



CLASSIC / LC

C1959

1 H.P., Stainless Steel

- Larger capacity - Lock cover/batch feed
- Automatic reversing switch
- Full 7 year parts and in-home service warranty

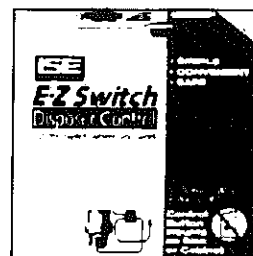

AAS-CH

C6889

- Air actuated switch